

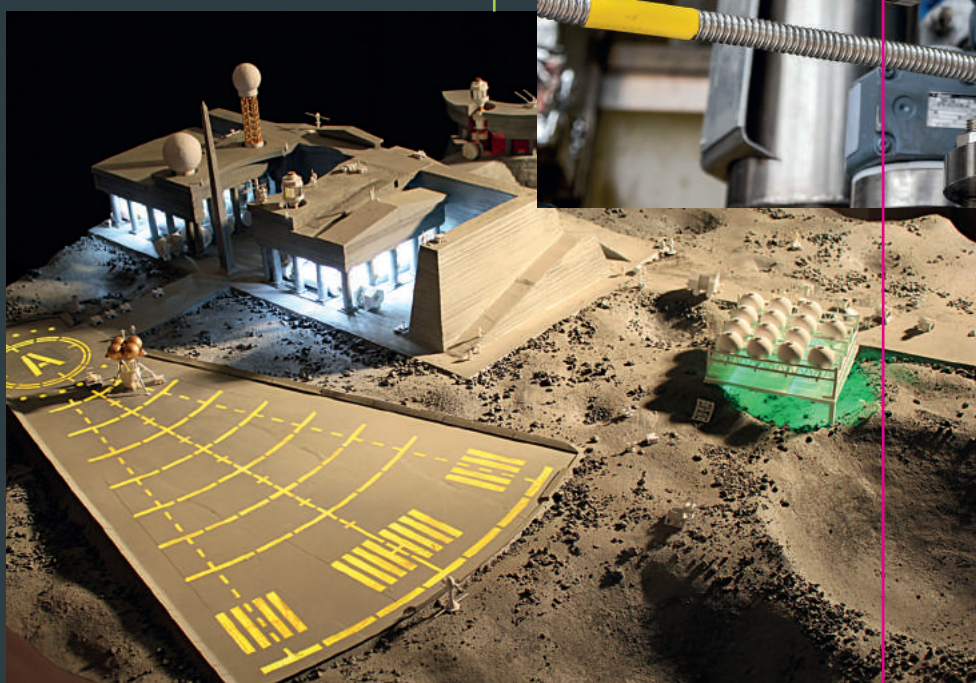

SSTU popular science edition

TECHNOPOLIS OF THE VOLGA REGION

Top digest 2016

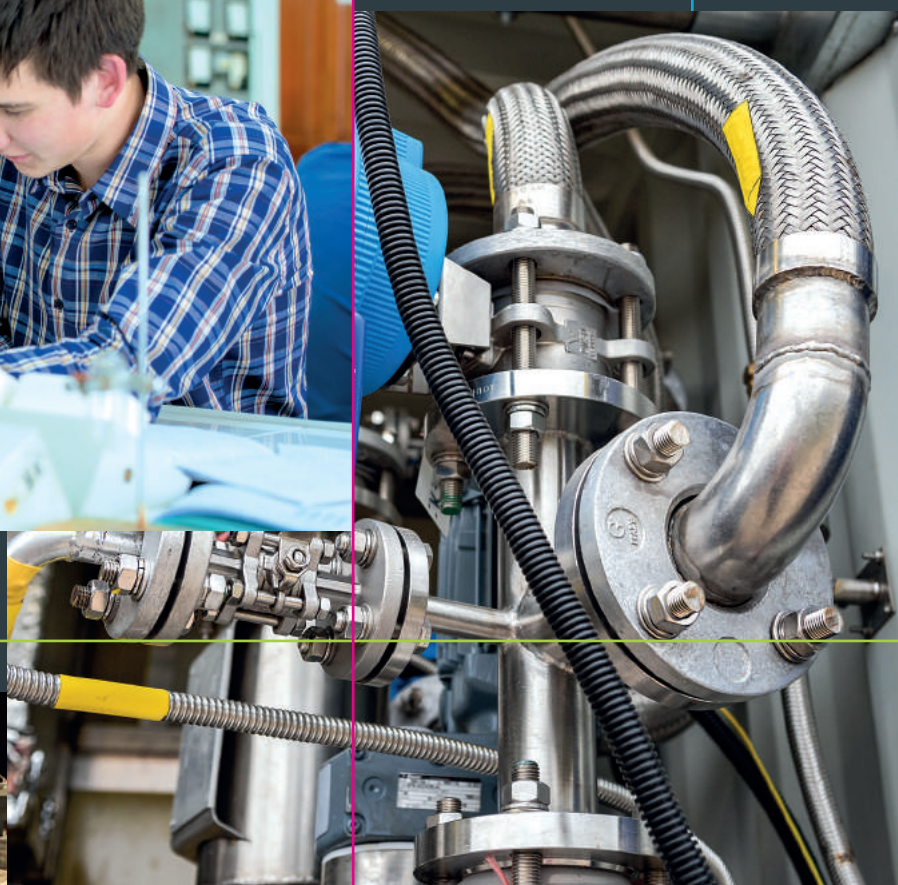

SSTU popular science edition

TECHNOPOLIS OF THE VOLGA REGION

Top digest 2016

Founder:

Federal State Budgetary Educational Institution of Higher Education
“Samara State Technical University”

Editorial

Editorial director: Dmitry Bykov
Editor-in-chief: Olga Naumova
Associate editor-in-chief: Maxim Eremin
Translation reviewer: Victoria Dobrova
Designer: Victoria Lisina
Photography editor: Antonina Stetsenko
Advertising manager: Elena Shaferman

Text and Production

Tatiana Vorobieva, Svetlana Eremenko, Eugenia Novikova, Ksenia
Morozova, Nelly Leonova

Address of the publishing house:

244, Molodogvardeyskaya Str., main building, Samara, Russia 443100
Telephone: (846) 278-43-57, 278-43-11
E-mail: tehnopolis.63@yandex.ru
Web page: www.samgtu.ru

The editor reserves the right to have the opinion which doesn't correspond with that of authors of the materials published and leaves their letters without answers. Any use of text and photos from the current issue is possible only with the written permission of the editor. Reference to the material used is obligatory.

Printed by «Aeroprint».
18 Zavodskoe Sh., block 3 «M», Samara, Russia

999 copies
Order № 17/03/0663 Submitted for publication: 13.03.2017
Date of publication: 27.03.2017

Free distribution among the partners of Samara State Technical University by means of addressed mailing.

Dear colleagues!

In 2016 Samara State Technical University made a huge leap forward. We changed substantially. It might seem not so evident but what is happening today at university is based on obvious logic. SSTU acquired the status of the flagship university of the Samara region and received a historic chance to become the engine of the economic growth in the region. It was a challenge.

We started to reorganize the educational process relying on the development of interdisciplinary connections. Last summer first “innovation teams” consisting of talented students, researchers and practitioners were formed at the University. Their goal is to develop competitive products in the form of technology, prototype or services and bring them to market. We have already achieved some positive results.

For example, one of the multidisciplinary teams created a method for producing an edible food wrap films from various plant raw materials. The film can be used as packaging for meat products, cheese, sandwiches and desserts. The packaged food can be heated in the microwave and eaten with the film. Now seven students from different faculties are involved in the project conducted by the staff of the Department of Technology and Organization of Catering. They work within various areas: methodology of organoleptic evaluation of the edible film, product testing and interpretation of the results, cost of films of different materials, supply of raw ingredients, capacity of the raw materials market, forecasting demand for a product, sales areas.

One more interdisciplinary team headed by Anton Rakov, Candidate of Architecture, and Vladimir Nikitin, Doctor of Technical Sciences, is developing geliolithographic laboratory for the construction areas on the Moon.

Partners and friends of SSTU appreciated the importance of our intentions and showed interest in their successful implementation. The evidence of it is a series of major events held at the university with the participation of famous Russian and foreign scientists, politicians and representatives of famous companies. The X Winter Symposium



Dmitry Bykov, Rector of Samara State Technical University, Honorary Figure of Russian Higher Education of Russia, chief editor of the journal *Technopolis of the Volga region*

on Chemometrics was held in our University in March; distinguished experts of this field of science from Russia, Italy, France, Denmark, USA, Germany, Hungary, Spain, Portugal took part in it.

Swiss-Russian Forum “Innovation Day” was held at SSTU on June 2. Participants discussed the innovations not only in industry, education, medicine, environmental issues, but also in international relations. In addition, we signed a memorandum of cooperation with *iLocal Integrated Service Nigeria Ltd* and consulting firm *Barbelsberg AG*. The matter concerns the construction of a refinery in Nigeria, and our University will be engaged in its design.

Last year university scientists succeeded to attract the attention of the scientific community due to a number of unique inventions. A new method for wear-resistance coating by detonation method was developed in the laboratory of nanostructured coatings. Our geologists proposed an original method for the study of rocks using the sludge to optimize oil drilling. Ecologists and chemists tested the system of decontamination of waste and residues of natural-gas odorant. Scientists of the Chair of Electronic Systems and Information Security in collaboration with the company *Network-centric platform* designed automatic control system for a cluster of UAVs.

A large scientific expedition including scientists from Samara State Technical University discovered leaf prints of ancient thelypteris-like fern aged 55 - 59 million years near the village Trubetchino. This extinct genus of ferns was previously known by findings in the Paleocene deposits in Canada, it didn't occur on the territory of Russia.

Popular science journal *Technopolis of the Volga region* provides information about outstanding people working in Samara State Technical University, their achievements, discoveries and prospects. It has been published since 2014 for university partners and friends. We invite everyone to take advantage of the publication as an open media platform for the strengthening of friendly relations and mutually beneficial cooperation.

editorial text

new part

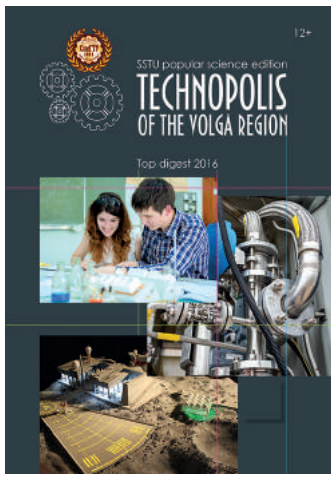

	1	2	3	4	5	6	7	8	9	10	11
12	13	14	15	16	17	18	19	20	21	22	23
24	25	26	27	28	29	30	31	32	33	34	35
36	37	38	39	40	41	42	43	44	45	46	47

CONTENTS

RECYCLING INSTEAD OF WASTE DESTRUCTION

FROM SAMARA TO LILLE AND BACK



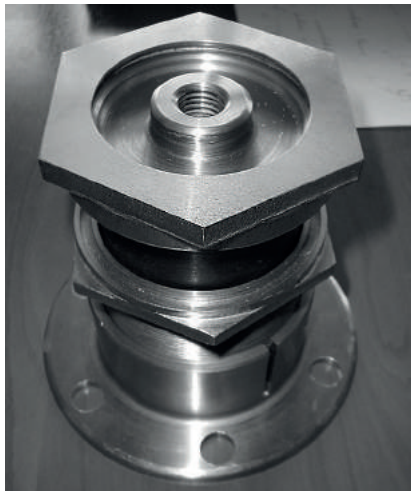

NO VIBRATION – NO HESITATION

48	49	50	51	52	53	54	55	56	57	58	59	60	61
62	63	64	65	66	67	68	69	70	71	72	73	74	75
76	77	78	79	80	81	82	83	84	85	86	87	88	89
90	91	92	93	94	95	96	97	98					

ALUMINUM CANS RECYCLING



A CLUSTER OF DRONES



STRAIGHT FROM PALEOGENE



SSTU IS INCLUDED IN THE LIST OF TOP – 50 UNIVERSITY REPUTATION RANKING

Agency RAEX (Expert RA) published the results of the annual research “University Reputation Ranking for consolidated directions.” SSTU is number 26 in the list *Technical, natural-science direction and science*. It was based on the results of a survey of students, alumni, academic and scientific communities, employers. It covers more than 60,000 respondents. It evaluated the quality of higher education, demand for graduates by employers and the level of research activities.



THE STUDENT OF SAMARA STATE TECHNICAL UNIVERSITY BECAME THE CHAMPION OF RUSSIA

Denis Obertyshev, a third-year student of the Heat and Power Department, won the Russian Junior Championship in athletics held in Kazan from 25 to 29 June. His triple jump of 16.38 meters was the best amongst 17 athletes. In addition, he set a personal record and now claims to be the Master of Sports.



SAMARA STATE TECHNICAL UNIVERSITY IS IN THE TOP 3 NATIONAL UNIVERSITY RANKING

The flagship University of Samara region became the third one after the National Research Nuclear University MEPhI and the St. Petersburg National Research University of Information Technologies, Mechanics and Optics in the ranking of the demand for engineering universities. On December 15 the Rating presented the project “Social Navigator” of the International Information Agency “Russia Today”.

In total, the study included 446 universities from across the country involving 132 engineering (technical) universities.

When drawing up the list such factors as employer’s demand for trained professionals, commercialization of intellectual products produced by the university, the need for research products were taken into account.



SSTU IS INCLUDED IN THE LIST OF BEST UNIVERSITIES OF EUROPE AND CENTRAL ASIA

According to the annual QS World University Rankings the Samara State Technical University was among the best 200 universities from 30 developing countries of Europe and Central Asia. Rating is based on some indicators including efficient use of Internet resources, publication frequency and the proportion of employees with scientific degrees.

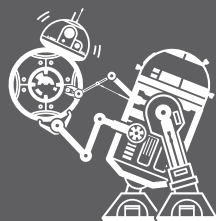

EDUCATIONAL CENTER OF ROBOTICS IS OPENED IN SSTU

Center for Robotics set up on the basis of University's Department of Automation and Information Technology together with the project *R2D2 Samara* provides a platform for the integrating of technical creativity elements in the learning process. According to experts, it not only provides technical and methodological support to the scientific activity of students. This is a complete testing area for the design of products and the preparation of the student teams to compete in robotics. It includes various educational programs for gifted children and workshops in design and programming.



THE STUDENT OF SAMARA STATE TECHNICAL UNIVERSITY BECAME THE GOLD MEDALIST IN THE WORLD PENTATHLON CHAMPIONSHIP

Alexander Lifanov, International Master of Sports, a third-year student of the Oil-Technological Department became the gold medalist in the World Junior Championship in modern pentathlon.

Alexander Lifanov and **Sergey Baranov** from Nizhny Novgorod were the first in the relay. In the team competition Alexander Lifanov with two pentathletes from Moscow **Vyacheslav Bardyshev** and **Danila Glavatskih** also won gold. In the individual competition he won a bronze medal, losing to rivals from South Korea and Guatemala.



CONCEPT OF SCIENTISTS FROM SSTU DREW UNESCO'S ATTENTION

At the UN conference *Habitat III* held in October in Quito UNESCO presented a multipage report about the experience on the development of urban spaces in 111 cities around the world. Specialists of the international organization were attracted by the strategy *Samara-2025* developed with the participation of scientists of Architecture and Civil Engineering Institute of SSTU. Svetlana Malysheva, Candidate of Architecture, dean of the Department of Design was a coordinator of the group dealing with the developing a creative city and the new urban environment. Her colleagues Sergey Malakhov (Professor), Eugenia Repina (Associate Professor) and Dmitry Khramov (Associate Professor) have repeatedly advocated for the establishment of the *City Institute* as a center for environmental design in Samara. Architects have proposed several original projects aimed at preserving and developing the unique urban and natural environment of megapolis *Big Samara*. One of the programs in particular implies the restoration of the first Samara fortress built in 1586. The ways of positioning of the metropolis *Big Samara* and the agglomeration *Zhiguli Ecumene* as the symbolic and geographic center of the river Volga are truly interesting not only for Samara inhabitants but also for residents of other cities of the Volga region.



SAMARA STATE TECHNICAL UNIVERSITY INTENDS TO COOPERATE WITH THE UNIVERSITY IN CHEMNITZ

In October a delegation from the Federal Republic of Germany visited Samara State Technical University. Frank Hagen, Head of Saxony Economic Development Department spoke about German companies and universities which intend to continue scientific and technical cooperation with SSTU.

First of all, it is Chemnitz University of Technology. This University shares similar experiences as SSTU in the management of educational and scientific activities. In addition, it has also had the process of integration recently; now it is composed of three technical universities. Colleagues from Chemnitz are ready to implement the programs of academic mobility for students and lecturers, to develop projects including the environmental protection, the study of heavy oil residues, the creation of polymers and composite materials. An Agreement on cooperation with the Chemnitz University will be signed during the return visit of the Samara delegation to Saxony.



GRADUATE FROM ACI OF SSTU IS THE AUTHOR OF THE TALISMAN FOR THE 45TH WORLD CHAMPIONSHIP WORLDSKILLS

A graduate of Architecture and Construction Institute of SSTU **Maxim Ovchinnikov** won the contest on creating a talisman for the 45th World Championship WorldSkills to be held in Kazan in 2019.

Experts evaluated 10 design projects which obtained the highest scores in the qualifying round using an online voting system. According to the jury a character named Skillsi showed the qualities of the WorldSkills participants as accurately and clearly as possible.

Maxim Ovchinnikov said that the image of the talisman was created thanks to his childhood passion for comic books about superheroes. The erudite and hardworking guy Skillsi succeeds in all areas of science, technology and art. A bag full of technologies as a tool in the hands of a professional is of great help in any difficult situation.

World Championship WorldSkills Kazan 2019 will be held from 18 to 23 August. The event is expected to attract more than 1500 competitors and 3000 experts in 50 working specialties from 76 countries-members of the movement WorldSkills International. According to preliminary estimates the event will be visited by more than 250 000 spectators.



THE INVENTION PRESENTED BY SSTU WAS AWARDED A SILVER MEDAL AT THE INTERNATIONAL EXHIBITION

In October Nuremberg (Germany) hosted the 68th International Trade Fair *Ideas - Inventions - New Products iENA-2016* under the patronage of the Bavarian State Government, the Federal Ministry of Education and Research, with the support of the World Intellectual Property Organization (WIPO) and the International Federation of Inventors' Associations (IFIA).

SSTU presented the invention *Method of hardening the surface of workpieces*. It was created by the team of 10 people under the supervision of the first vice-rector of the university Maxim Nenashev. The method uses the activation of the treated surface in the presence of radical substance followed by chemical and thermal processing of the workpiece. Then it is heated up to the temperature of radical chemical modification of the substance. Detonation perforating of the surface layer is used as an activation method.

For this invention SSTU was awarded a silver medal. Trade Fair *Ideas - Inventions - New Products* is considered to be the oldest and most prestigious and innovative event in Europe where the most interesting innovations in various fields of science and technology are demonstrated. For Russian scientists and inventors it provides the opportunity not only to show their developments but also to attract investments.

DEMAND FOR INNOVATION

Prospects of the Russian-Swiss cooperation development were discussed in SSTU



Samara State Technical University was not accidentally chosen as the place for the Second Russian-Swiss Forum “Innovation Day”. For several years SSTU has been a full member of the Russian-Swiss industrial Business Club representing a communication platform of the Russian industrial enterprises. Cooperation agreements between the university and a number of Swiss companies have already been signed.

The forum was one of the main events of the year in the sphere of international relations between Russia and Switzerland. Undoubtedly, it created a new impetus to the development of partnership relations between Samara State Technical University and large Russian and foreign companies. The participants of the forum

discussed innovations not only in industry, education, medicine, environmental issues but also in international relations.

The plenary session highlighted the activities of Swiss investors in Russia, especially pharmaceutical companies Novartis International AG and F. Hoffmann - LaRoche AG, as well as machine-building holding Liebherr AG and electrical group ABB.

ORGANIZERS:

- Honorary Consulate of the Russian Federation in Lausanne
- Russian Engineering Union
- The Government of Samara region
- Swiss-Russian Industrial Business Club

PARTICIPANTS:

“Schwabe-Nanotech», Ferring, CSEM, Swissmem, Mikron SA Agno, EPFL, University of Neuchâtel, as well as leading innovators, scientists, politicians of Russia and Switzerland.

MEMORANDA OF COOPERATION WERE SIGNED BY:

- Company “Alpine-Zhiguli business center” and Swiss Center Samara Sàrl (Switzerland) on Understanding in the field of transfer of technology and capital.
- SSTU, Barbelsberg AG (Switzerland) and iLocal Integrated Service Nigeria Ltd on construction design of refineries in Nigeria.
- Ufa State Oil Technical University and the company Progress Ultrasonics AG on a joint venture aimed at the scientific solution of investment projects related to construction and reconstruction of oil producing, petrochemical and gas complexes on the territories of Russia, Kazakhstan and other countries.

VLADIMIR GUTENEV,

FIRST VICE PRESIDENT OF RUSSIAN ENGINEERING UNION, STATE DUMA DEPUTY:



- The fact of holding the forum “Innovation Day” on the Samara land is very positive. The machine-building complex and scientific organizations of the Samara region significantly contribute to all sectors of Russian industry. High scientific, technical and human resources of the companies, which are leaders in their fields, provide a solid foundation for the successful development of joint projects.

PIERRE HELG,

AMBASSADOR OF SWITZERLAND IN RUSSIA:

- Each country develops in its own way. The dialogue between the scientific and business elite should be continued in order to turn into a mutually beneficial cooperation. This Innovation Forum provides an excellent opportunity for this.



ALEXANDER KOBENKO,

VICE-GOVERNOR, MINISTER OF ECONOMIC DEVELOPMENT, INVESTMENTS AND TRADE IN SAMARA REGION:



- It was no coincidence that Samara region was chosen as the place to hold the forum. We regularly exchange experiences with the Swiss partners in the framework of bilateral visits. The second Forum “Innovation Day” is not only a discussion, but also an opportunity for business people and academics from Switzerland to receive first-hand information about the Samara region.

- There is a lot of Swiss companies and universities among our university partners. We exchange ideas and share experiences. It is a great honor for our university to hold a forum. Here are eight of the largest universities from different regions of Russia that demonstrate willingness of Russian scientists and businessmen to collaborate.

DMITRY BYKOV,

RECTOR OF SAMARA STATE TECHNICAL UNIVERSITY:



- Forum “Innovation Day” in Samara makes possible the establishments for the further cooperation between Switzerland and Russia in the fields of medicine, education, culture and science. I am convinced that Russian-Swiss dialogue will allow us to make new discoveries.

FREDERIK PAULSEN,

PRESIDENT OF THE INTERNATIONAL PHARMACEUTICAL COMPANY FERRING PHARMACEUTICALS, HONORARY CONSUL OF THE RUSSIAN FEDERATION IN LAUSANNE:



SERGEY TSYB,

DEPUTY MINISTER OF INDUSTRY AND TRADE:



- We appreciate and fully support the efforts of business communities and industrial companies of Switzerland to continue quiet practical work on the implementation of joint projects. Despite all the geopolitical issues and the difficulties in the global economy, the Swiss Confederation remains an important European partner in the industrial sector and a supplier of advanced technology for our country.

JEAN NATHANAEL KARAKASH,

PRESIDENT OF CANTON OF NEUCHÂTEL :



- The II Forum “Innovation Day” coinciding with the official visit of the delegation from the Canton of Neuchâtel to Samara offers a great opportunity to strengthen links between Switzerland and Russia in the field of business and science. This experience is very important for the formation of a mutual understanding of bilateral cooperation prospects.



INNOVATION EXPERIENCE

The SSTU scientists' developments were presented at the international conference

By Alexandra ISHIMOVA

Relevant development for oil and gas industry were looked into at the international conference 'General engineering in oil production: experience, innovations, development'. It took place on the 24th-26th of August in Samara and was dedicated to the 70th anniversary of one of the oldest design institutes in our country – 'Giprovostokneft'. The presented projects were featured by the combination of practical significance and scientific justification. The SSTU scientists took active part in the forum.

Representatives of mineral developer companies, service organizations, oil and gas equipment manufacturers, research and development institutes and scientific centers met at the conference. The contributors noted that much of the technical solutions currently used in oil industry had been developed by the specialists of the Samara design institute: pressure-sealed gathering systems, various ways of increasing the reservoir recovery, typification of installations for primary oil treatment, method of sectional measuring of well yield and many others. These developments have been implemented and utilized in different regions of our country and abroad.

In order to carry out the full range of survey and design work the 'Giprovostokneft' design institute usually forms a separate project office especially when working on extremely difficult projects such as the one developed for 'Taas-Yuryakh-Neftegazdobyicha'.

Since 2009 'Giprovostokneft' in cooperation with 'SK 'RUSVIETPETRO'' has been delivering the project of oil and gas well site construction in the Komi Republic acting as the general constructor and engaging other designers who have the experience of working in this region.

Specialists of 'SchneiderElectric' told about the latest achievements in the area of power-generating equipment. The company has the special department for cooperation with 'Giprovostokneft'. One of the notable examples of this cooperation is the construction of main trunk line called 'Caspian pipeline consortium'. The partners built the systems for dispatching, telecommunication, uninterruptable power supply and electric power supply.

Project of the resource-efficient oil treatment unit which utilizes the technology of soft steam stilling and drew attention of many forum participants was developed by the SSTU scientist **Leon Grigoryan**. The project was implemented with the support of 'Giprovostokneft' and a participation of the design institute technologist – SSTU graduate **Denis Ignatenkov**. This innovative technology significantly reduces corrosion and atmospheric emissions during the oil processing, eliminates the negative effect of

hydrogen sulfide and also removes formaldehyde from end product.

IT specialists of 'Giprovostokneft' came up with a project of neural integrated control performed by virtual operator. It was presented as a project of the future and was met with some skepticism. But the institute has already implemented many sci-fi projects.

Most of the conference activity took place at the section called 'Enhancing the efficiency of oil field development and well construction'. Most contributions were focused on the methods of oil recovery increase using different methods of evaluation and analysis – laboratory computer simulation research. All contributors agreed that complex approach was required to solve this problem: from experiment, technological and economic calculations to industrial experimental work that would justify the developed methods.

Contributions on import phase-out of the reagents needed for physical-chemical recovery methods were recognized as relevant and up-to-date. Head of the SSTU department 'Oil and Gas Field Development and Operation', Candidate of Chemical Sciences **Viktor Kononov** told how to make active solutions out of low-quality hydrocarbon crude (which is the production waste) to enhance oil recovery.

First methods for development of the Urals-Volga region oil fields were developed by the staff of the process-specialized department formed in 1946 when the institute was founded. In 7 years the staff members made an outstanding contribution into the development of this branch of industry: designers came up with a number of unique ideas how to enhance oil recovery. About 105,000 conventional cores were analyzed in the institute laboratory of oil stratum physics. The members of the staff were awarded with the Lenin Peace Prize for developing the block flooding pattern. They were also awarded with the medals of Exhibition of Economic Achievements.

Today 'Giprovostokneft' and the All-Russian Research Institute are parts of 'Zarubezhneft'. The two institutes carry on joint preparation of development documents, laboratory research and mutual expert appraisals.

The contributors also talked about the methods of effecting bottom-hole formation zone to intensify oil production. Among them there was the method of polysound impact developed by the SSTU associate professor **Igor Tsarkov**, and the heat tracing performance assessment method developed by the SSTU graduates **Andrey** and **Irina Dolzhikov** together with their scientific adviser, Candidate of Physical and Mathematical Sciences **Andrey Tyutyayev**.

Specialists also paid attention to the sludge study method represented by the senior lecturer at the SSTU Geology department **Alyona Morova**. This method is especially important when studying the layers which are believed to be water-saturated according to geophysical data but they are actually oil-saturated.

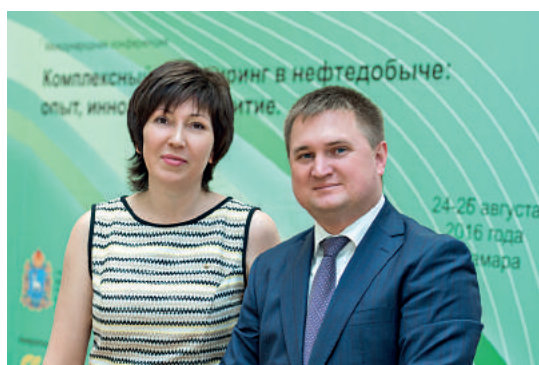



Andrey MEDNIKOV, CEO of 'Giprovostokneft':

"The conference gave us the opportunity to show the potential of the companies, strengthen the business ties, expand the cooperation horizons, discuss relevant problems and issues that the oil and gas industry faces today."





Rinat ISMAGILOV, head of the department of forward planning, conceptual engineering and re-engineering at 'GPN-Razvitie':

"Oil companies are aimed at project management and enhancing the major projects' implementation efficiency; so there's the need for conceptual and general engineering. As 'Giproostokneft' has a great number of competences and experience in arranging general projects, it possesses significant potential to develop this line."





France

POINTS OF CONTACT

FROM SAMARA TO LILLE AND BACK

A SSTU postgraduate student receives training in a joint educational program of SSTU and a European university

By Tatiana VOROBYOVA

Young researchers from the Chemical-Technological Faculty take active part in implementation of the SSTU innovative projects. For example, Maria Kulikova, a postgraduate student, employs a completely different approach to the development of highly-efficient catalysts for hydrofining. She is carrying out her candidate thesis research on the base of two universities: SSTU and the Lille University of Science and Technology. Maria applied for the young scientists' mobility support program of the French embassy in Russia and won the grant for training in France.

DP

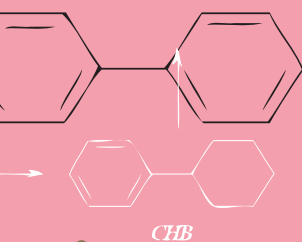

TOP DIGEST_2016

16

Joint postgraduate study

After graduation from SSTU **Maria Kulikova** worked in the Organic synthesis research institute for about a year; as she saw no prospects for further development there she came to the department of Chemical Technology of Oil and Gas Refinery. While working as an engineer there she became interested in scientific work carried out by the department officers, made acquaintance of her future scientific adviser, chose the subject of her scientific investigation and started her own research.

Maria's scientific adviser – **Pavel Nikulshin**, Doctor of Chemistry – cooperates with the scientists of the Lille University. It was they who suggested that Maria should take part in the competition and try to get the Vernadskiy research grant provided by the French government. Maria found out the competition results last spring and began preparing for her trip to France. She turned out to be the first SSTU postgraduate student to receive training under the joint Russian-French educational program.

Maria's scientific adviser at the Lille University was Professor **Carol Lamone**, head of the laboratory of solid body catalysis and chemistry. This laboratory is the leader in the area of development and research of the hydroprocessing catalysts for oil refinery in France.

Experiments on the 'Sun'

The postgraduate program rules require a student to spend no less than 12 months in three years in the French university and then defend his thesis. The first time Maria went to France was in October 2015.

“The University of Lille is huge, one of the biggest universities in France, there are many foreign students and postgraduates there,” Maria says. “French professors are very sociable and friendly. My scholarship was 750 Euro a month so I could pay for my accommodation in France. Last year I also got a scholarship from the Dutch company called ‘HaldorTopsøec’ – world leader in the area of catalysis – and it was a great help too.”

Maria says that the Lille University provides its postgraduates with many pieces of unique and expensive equipment required for up-to-date research work. There is no such equipment in SSTU so Maria had to send her samples to Moscow and Kazan for analysis.

“In Lille I got the opportunity to analyze the samples by myself as well as to adjust the parameters and conditions of my experiments. It is very interesting and useful in terms of understanding the research subject,” Maria says.

Using the potential of the Lille University laboratories Maria Kulikova carried out complex multistep synthesis of a number of multicomponent molybdenum-wolframite heteropoly acids; she also proved their contents and structure. As a postgraduate student Maria was supposed to conduct an experiment on the station of synchrotron

radiation called ‘Soleil’ (a French word for ‘Sun’) which was a huge scientific facility. But the sophisticated experiment called ‘EXAFS’ (Extended X-ray Absorption Fine Structure) wasn't the end – the obtained data. After the special training Maria learned the methods for interpretation of the obtained results including the chemometrics methods.

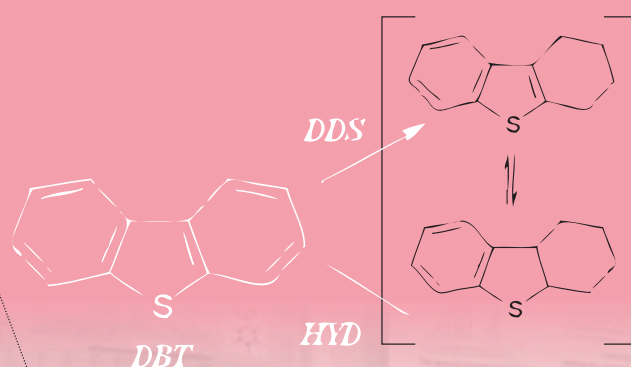

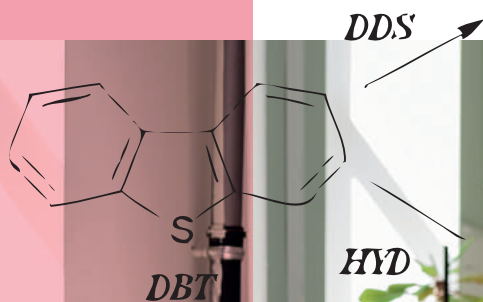

Active and effective

Maria's goal is to create high efficient catalysts to be used in hydrofining to remove sulfur and nitrogenous compounds from diesel fuel oil and black oil fuel. For such catalysts Maria employs completely new approach – she uses multicomponent heteropoly acids she synthesized herself as a predecessor of active phase particles.

The **EXAFS spectroscopy** helps the researches to identify structural parameters of the closest environment of atoms.

These acids contain two types of metal so they can be used to create an overactive center.

“Quantum-chemical calculations show that nickel-molybdenum-wolframite sulphide clusters can be more active than their bimetallic analogs. We managed to create a catalyst which is more effective than any other that we have now. At the present time the team of Russian and French researchers is processing the data obtained during the EXAFS experiment. “If we really manage to get a multicomponent active center, it will be a major scientific achievement,” Maria explains.

The subject is of great scientific interest; development of such catalysts with new properties is another step closer to meeting the challenge of substituting foreign petrochemical catalysts with domestic ones.

To be concluded

This September Maria took another long trip to France to continue her training. She will spend about 9 months in Lille and test another line of catalysts she synthesized in Samara; she will also carry out the synthesis of heteropoly compounds with higher molybdenum content. A number of experiments on the station of synchrotron radiation are also to be carried out.

Maria enjoys her scientific work: “When a catalyst ‘does the thing’ and we get interesting results, it’s very satisfying and at the same time it raises a number of questions that can be answered by additional research only. It’s great and difficult at the same time. Scientific research takes practically all my time. My working day in the laboratory of the Lille University is from 9 a.m. to 7 p.m. And at the SSTU Department of Chemical Technology of Oil and Gas Refinery tests last for 24 hours a day and we often work in shifts. It’s a usual thing for us to come to work on Sunday and come home late at night.”

Defense of Maria's candidate thesis is scheduled for autumn 2017. But Maria hopes that she will be able to do this earlier as she has accumulated large amount of data.

70 YEARS
OF WORK EXPERIENCE
IN 25 COUNTRIES

JOINT-STOCK COMPANY
INSTITUTE FOR DESIGN AND
RESEARCH IN OIL INDUSTRY

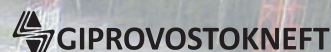

INTEGRATED RESEARCH AND DESIGN

EXPLORATION PLANNING AND SUPERVISION

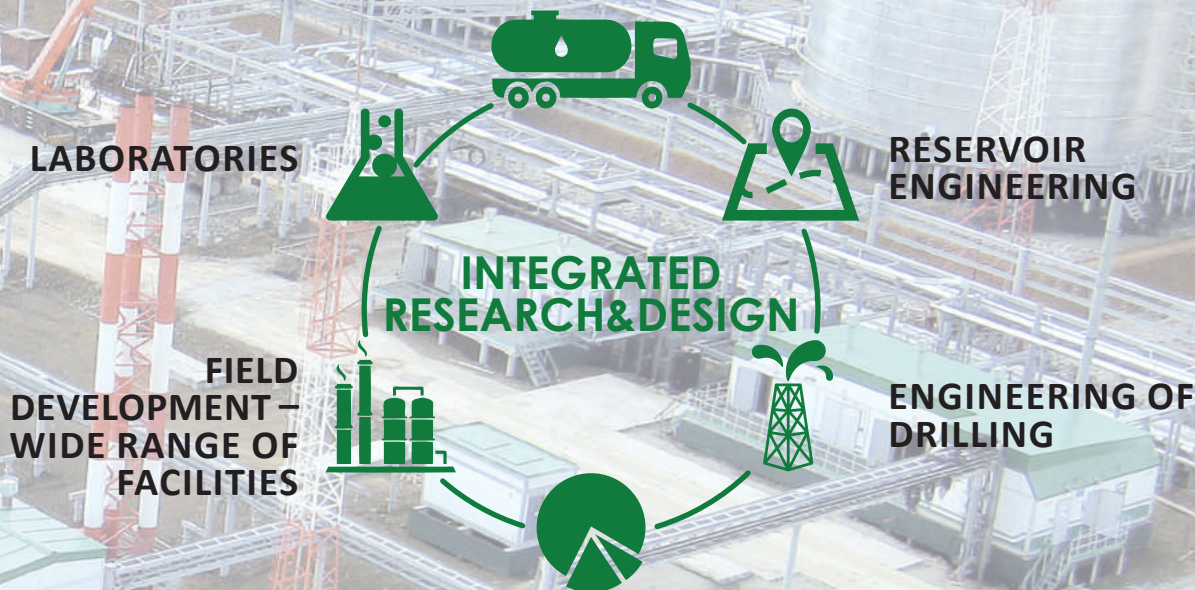

CONCEPTUAL DESIGN. DEVELOPMENT PROGRAMS AND
CONFIGURATION SCHEMES OF OIL AND GAS
PRODUCTION COMPLEXES

- SYNERGETIC EFFECT FROM DEVELOPMENT OF ALL REGIONAL OIL ASSETS: MINIMIZATION OF COSTS FOR GENERAL INFRASTRUCTURE FACILITIES (PIPELINES, OHPL, SOCIAL INFRASTRUCTURE FACILITIES)
- IDENTIFICATION OF ASSET TECHNOLOGICAL UPSIDE
- INTEGRITY OF ACCEPTED SOLUTIONS BY INTEGRATION OF DIFFERENT PROCESS OPTIONS
- STRATEGIC VISION OF ASSETS: FROM THE IDEA UP TO DISPOSITION

GIPROVOSTOKNEFT DESIGN&SURVEY CAPABILITIES.
MODERN APPROACHES AND DESIGN ENGINEERING PRACTICE
FOR OIL AND GAS PRODUCTION AND TRANSPORTATION FACILITIES

93, KRASNOARMEISKAYA ST., SAMARA, 443041, RUSSIA, GIPROVOSTOKNEFT JSC
TELEPHONE: +7 (846) 333-46-96. FAX: +7 (846) 279-20-58. E-MAIL: GIPVN@GIPVN.RU
WWW.GIPVN.RU



OUR PEOPLE IN KUDANKULAM

Graduates of Samara State Technical University made their contribution to an implementation of the global international project

By Tatiana VOROBYOVA, Denis NAGANOV



POINTS OF CONTACT
India

On the 10th of August President of Russia Vladimir Putin and Prime Minister of India Narendra Modi by means of videoconference took part in the opening ceremony. It was the first power-generating unit of the Kudankulam nuclear power plant built with the help of Russian experts that was handed over to India. Specialists of 'Electroshield Samara' including some SSTU graduates took part in the implementation of the biggest joint Russian-Indian energy project.

Designing and production

In 2005-2007 Samara company 'Electroshield' built and shipped to India the 6 kV switch gears to generate power for the first and the second power-generating units of the Kudankulam nuclear power plant. Practically all divisions of the 'Electroshield' production facility made their contribution to the construction of the nuclear plant which is supposed to supply the southern states of India with electricity.

During the implementation of the project **Pavel Matveev** was the key specialist in the field of foreign economic activity and nuclear power engineering in the enterprise management. He graduated from the Physical-Technological department of SSTU and today he works as a manager who deals with regional clients. He says that the shipping contract was signed in August 2003 and then 'Electroshield Samara' came to agreement with the customers about all technical details and began to design and manufacture the pieces of electrical equipment.

"Switch gears for the Kudankulam nuclear power were highly sophisticated in terms of design and operational parameters.

The process of designing the units was labor-intensive and time-consuming as it required much concurrence so we asked the Moscow design institute 'Atom-Energoproekt' to help us. Our task was to integrate the switch gears into the control system of the nuclear power plant during the design period.

Russia helped India to build two power-generating units for the Kudankulam nuclear power plant; these units are equipped with nuclear reactors 2 thousand megawatts each. The second reactor of the Indian power plant will be soon put into operation. Eventually there will be five power-generating units at the nuclear power plant.

When the technical documentation was ready, the plant started to manufacture the units. Electric cabinets were designed for operation at the nuclear power plant in tropical climate and it was quite a challenge. The equipment was given the '2O' safety rank – the highest rank for electrical products.

The equipment was accepted by the representatives of the customer and by special organizations authorized by the Indian government. They carefully monitored all processes at the 'Electroshield' plant, starting from purchase of parts and components to check assembly and operation tests of all units.

▼ Pavel Matveev, Ramil Ismangulov and Yuri Alexandrov were working on the project for a long time.





As a result we shipped a big part of 6 kV switch gears with LF load-break switches and SIPROTEC microprocessing protection – 465 cabinets in total. Just imagine– at that time the ‘Electroshield’ plant used to produce 600-800 cabinets per month,” Pavel Matveev told our magazine.

On the ocean shore

It was very important project for the ‘Electroshield’ engineers as they had to meet its special requirements. They had

to improve and sometimes re-design some pieces of equipment in order to adapt them to new standards.

One problem occurred during the installation of microprocessing protection with special programming into the cells. But finally the process was adjusted and the devices were parametrized. The installed algorithms were tested with participation of the ‘Atomenergoproekt’ specialists and proved to be functional.

But the work wasn’t over after the equipment had been accepted by the customer: service officers of ‘Electroshield’ took several trips to India for contract supervision and test works at the nuclear power plant.

The first time when the graduates of the SSTU Electro-Technical department **Yuri Alexandrov**, head of the service department of 'Electroshield Samara', and **Ramil Imangulov**, an engineer, went to the Indian nuclear power plant, was in the spring 2006.

"We took our first trip to India because some third-party companies postponed the shipment of load-break switches. The switches were sent to the nuclear power plant slightly later than the basic equipment. As we shipped the switches separately we promised that we would do our job properly, and our **Indian colleagues** trusted us. For about a month we were **working in the climate we weren't used to: it was the southern part of India, near the ocean shore, and the weather was very hot and damp there. Not only were we carrying out production works but also training the local personnel how to operate our equipment,**" Alexandrov recalls.

Warranty lifetime of the switch gears is five years but much later the 'Electroshield' service officers upgraded the equipment: 'Electroshield' management realized that the Kudankulam nuclear power plant was an important strategic object and that the 'Electroshield' engineers were responsible for its uninterrupted operation.

"The cells made by 'Electroshield' had been in operation since 2010 and our last trip to India was in 2015 when we upgraded the cells by the agreement with our Indian partners," Yuri Alexandrov says. "Our Indian colleagues were always satisfied with the results of our work trips and sent letters of appreciation to our plant."

The products of 'Electroshield' proved to be reliable: Samara-made electrical equipment remained functional even after the tsunami that caused severe damage to the southern coast of India.

A significant event

Bringing the Kudankulam nuclear power plant into operation became a significant event for India, because, on the one hand, it has quite developed industry, and, on the other hand, many regions of the country use wind generators and solar panels for power generation. And the 'Electroshield' engineers have gained new experience which will be useful for them in the nearest future for a coming large-scale project on Cuba. But that's another story.

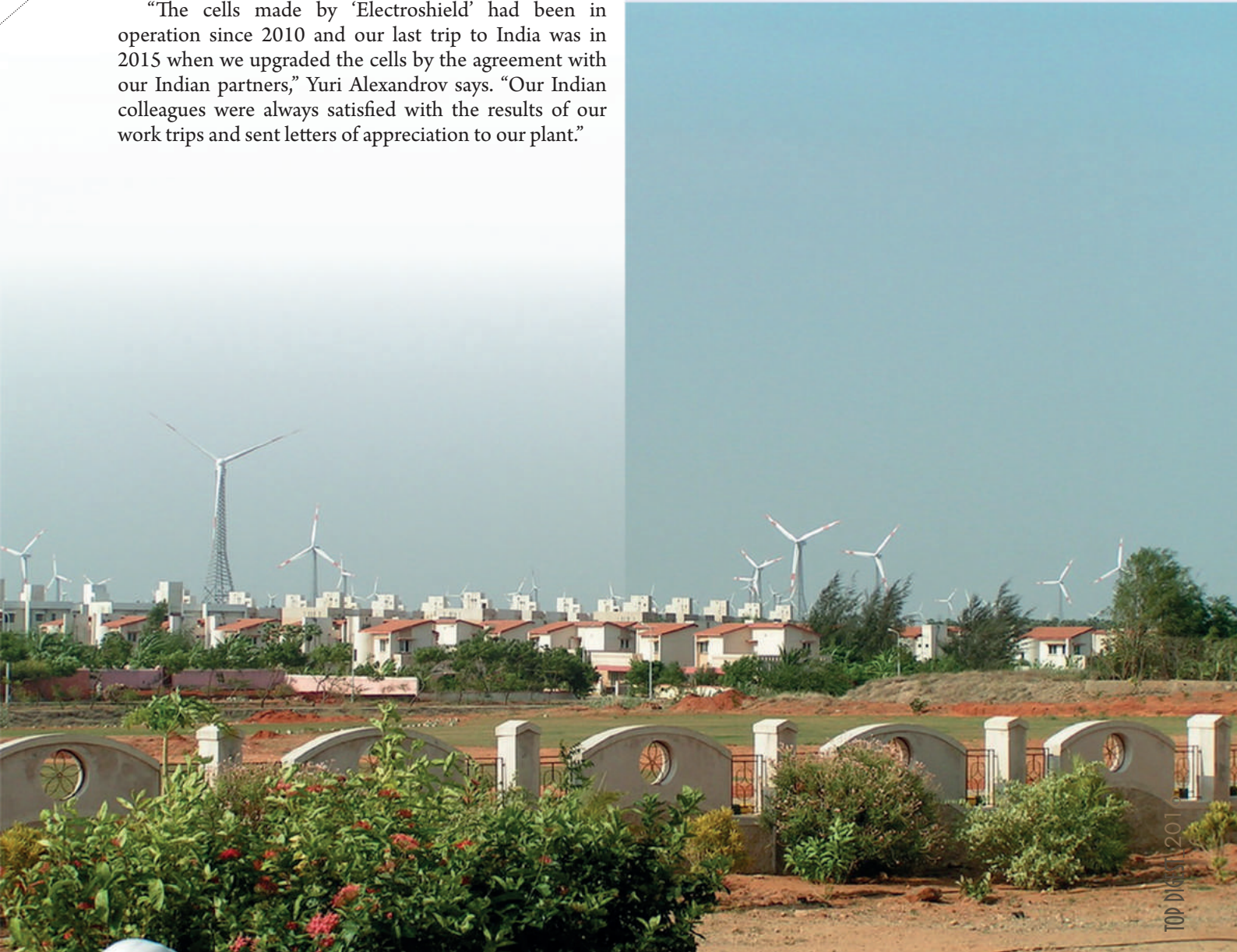

TAKE IT ON MEASURE

10th International Winter Symposium on chemometrics was held in SSTU from the 29th of February to the 4th of March

By Tatiana VOROBYOVA

Scientists from Russia, Italy, France, Denmark, the USA, Germany, Hungary, Spain, Portugal, as well as the representatives of major manufacturing companies such as 'FOSS Electric', 'ECAN', 'Scheltec AG' and 'SiSort' took part in the symposium.

Made in SSTU

This year the participants of the conference have seen the beta-version of TPT Cloud – a piece of educational software

unanimously admit that this software is unique as it has no analogs in the world.

“As a matter of fact, what we have is a Web application,” explains **Vladislav Galyanin**, one of the TPT Cloud

developers and head of the laboratory of multivariate data analysis and global simulation.

“In particular, it enables a lecturer to communicate with students in interactive mode without using additional instruments. This system is able to work with many users simultaneously. No other educational platform is so handy and user-friendly.”

Chemometrics is the branch of chemistry that employs mathematical, statistical and other methods based on formal logic; it is used to design and choose the optimum measuring procedures and experiments, as well as to get the most important and reliable chemical information during the analysis of experimental data. Chemometrics as a separate branch within analytical chemistry was founded in early 1970s by the chemists Bruce Kowalsky (USA) and Svante Wold (Sweden).

developed by the SSTU programmers. It is an easy-to-use free-access educational platform designed for sharing, storing and simulating the spectral data. The experts

The scientists of St. Petersburg State University have already appreciated this new software product developed for explanation of chemometrics methods. TPT Cloud is used in St. Petersburg State University to train the undergraduates.

Andrey Pimenov, PhD of Chemical Sciences, vice-rector on international relations of SSTU:

"Today the chemometrics methods are used in different practical areas, from analysis of oily waste to foodstuffs production. Chemometrics allows to establish relations between different data arrays that seem to be independent of each other or when they are dependent but it's not obvious. Scientists of our university actively use the chemometrics methods in their candidate and doctoral thesis research and the obtained results often present the scientific novelty of their theses. These methods help to achieve unique results."

Andrey Bogomolov (Russia-Germany), head of the SSTU chemometrics school of thought, senior scientific officer of the laboratory of multivariate data analysis and global simulation, gave a talk as a co-author of a number of reports; he also was awarded with badge of honor by Russian Chemometrics Society – "For the valuable contribution to the development of chemometrics in Russia".

Anastasia Melentyeva, engineer of the laboratory of multivariate data analysis and global simulation at SSTU, Candidate of Chemical Sciences, was qualified to take part in the international conference on chemometrics in Spain for free as she had done the research on identifying the content of fat and protein in milk.

Professor **David Hopkins** (USA) gave a talk on 'Using the method of derivatives relations in regression' which gave rise to the heated discussion.

Aleksey Pomerantsev (Moscow), chairman of the organizing committee of Russian Chemometrics Society, stressed out that chemometrics helped to reveal the ulterior relations and gave the solution for the problems that hadn't been discussed before because of their complexity.

Professor **Riccardo Leardy** (Italy) told how the multivariate data analysis helped him to understand why the Italian polymer-manufacturing company production wasn't always of the same quality and that it took him only a half of an hour to do that.



Professor **Louis Dupontel** (France) explained that he used spectroscopic methods to find out the concentration of metabolites in the human organism and that the obtained data could be used for diagnosing and instituting therapy.

Vladislav Galyanin, head of the laboratory of multivariate data analysis and global simulation at SSTU, told about a new approach to the model optimization with the use of up-to-date software.



ACCORDING TO UNESCO

Sustainable Development Strategy of Samara has obtained worldwide recognition

The United Nations Conference on Housing and Sustainable Urban Development, HABITAT III, was held from 17 to 20 October in Quito. Driven by concerns about the influx of population to megacities around the world, experts adopted a new agenda aimed at ensuring

transparency, security, viability and sustainability of settlements.

During the conference (which is held only once in 20 years) UNESCO has introduced a multipage report where the practices of 111 cities located in all continents of the planet were reflected. The International Organization on Education, Science and Culture has recognized them as

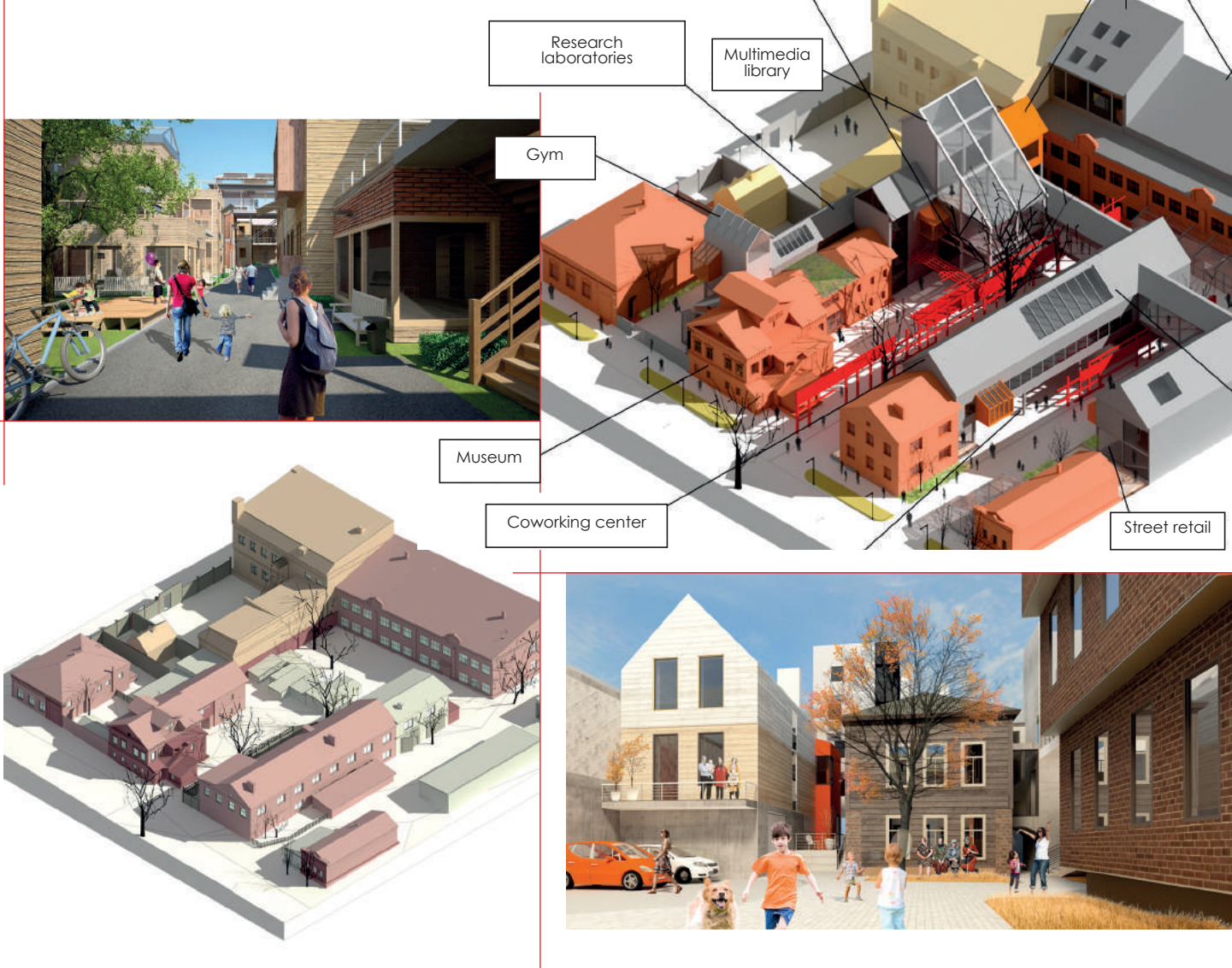

the most successful ones from the perspective of urban space development.

Samara was one of the two Russian cities (the second one is Kolomna) in the list approved by UNESCO experts. They appreciated the quality of the strategy *Samara-2025* (more than 3,500 residents were involved in its development in the two years), the concept of sustainable development in Samara's historic center, as well as the proposal to create distributed university campus in this area.

Technopolis of the Volga region found out that the strategy *Samara-2025* was developed with the direct participation of the scientists from the Architecture and Civil Engineering Institute of SSTU. **Svetlana Malysheva**, PhD of Architecture, dean of the Department of Design was a coordinator of the group dealing with the formation of a creative city and the new urban environment. Her colleagues Professor Sergey Malakhov and Associate Professors **Eugenia Repina** and **Dmitry Khranov** had repeatedly advocated the establishment of the City Institute in Samara as a center for environmental design. The architects have proposed several original projects aimed at preserving and promoting the unique urban and natural environment of the metropolis

Modern strategic guidelines of the integrated development of Samara were set five years ago. They appeared in the years 2011-2012 thanks to the initiative groups of citizens, experts and consultants. The strategy includes the assessment of the situation of the city development, possible scenarios for the future of Samara, and ways to implement strategic plans.

Big Samara. One of the programs, in particular, implies the restoration of the first Samara fortress built in 1586. The ways of positioning of the metropolis *Big Samara* and the agglomeration *Zhiguli Ecumene* as

the symbolic and geographic center of the river Volga are truly interesting not only for Samara inhabitants but also for residents of other parts of the Volga region.

International organization report states that this strategy of "soft renovation" was particularly effective. It showed that public is one of the main underappreciated resources for historical environment recovery. Restoration of the practices of "organic" development and new unsubsidized economic model should be studied in the future.



Established in 1914 Samara State Technical University is committed to the purity of science, research and innovation. Samara State Technical University is one of the oldest universities in the Volga region. It has a very long and rich history. SSTU nowadays is the biggest research and educational center of the region. We prepare specialists in the following fields: energy, oil and gas, chemistry and petrochemistry, mechanical engineering, transportation, food production, defense industry, information technology, mechanical and automotive engineering, engineering systems administration and automation, material science and metallurgy, biotechnology, industrial ecology, architecture, civil engineering and design.

The University is licensed by the Ministry of Education and Science of the Russian Federation to implement the educational activity in the field of higher education (License № 1938 from 17 February 2016).

The University is accredited by the Ministry of Education and Science of the Russian Federation (State Accreditation Certificate № 1676 from 22 January 2016).

University alumni successfully put into practice acquired knowledge. SSTU graduates are highly valued at the labour market. Our university alumni hold positions of Samara enterprises and organizations administration.

There are 10 faculties at the University: Chemical Engineering, Engineering and Technology, Petroleum Engineering, Electrical Engineering, Thermal Power Engineering, Engineering Economics, Mechanical and Automotive Engineering, Food Production Technologies, Automation and Information Technology, Humanities and also Architecture and Civil Engineering Institute.

Education is conducted in 24 integrated groups of specialties and areas of training (about 70 degree programs including Bachelor, Master Programs and 20 PhD Programs). More than 21 thousand of students study at the university. There are 1472 members of teaching staff including 778 professors with PhD degrees and 200 Doctors of Science. All the degrees offered have been designed to provide students with professional knowledge and skills. All the programs aim towards the development of theoretical and practical skills.

SSTU's educational, scientific and social infrastructure is quite developed. Nowadays the University embraces 3 main campuses, 17 educational buildings, 8 dormitories, more than 50 research centers, 2 sport complexes and 3 recreation centres. More than 1250 students live in university dormitories which are situated in the center of the city and equipped with everything needed for students' life.

Scientific and educational efficiency of our university and positive dynamics in the Russian rankings prove the sustainable growth of SSTU. In the National University Ranking "INTERFAX" in 2016 SSTU took the 65th place out of 238 Russian universities. Within Top-100 Russian universities ranking held by RAEX our university is on the 52nd position. As far as the international rankings are concerned, SSTU has participated in four rankings and has achieved quite impressive results in 2016: Academic Ranking of World Universities European Standard (ARES) – we rank №55 out of total 173, Webometrics Ranking of World Universities (70 out of 1417), University Web Ranking 4 International Colleges & Universities (80 out of 386), QS University Rankings: EECA (Emerging Europe and Central Asia) - our position is ranked 151-200.



SSTU



INTERVIEW

D MITRY BYKOV: “WE WILL INVEST EVERYTHING IN HUMAN CAPITAL”

SSTU Rector speaks on SSTU reputation, on joining SSUACE (Samara State University of Architecture and Civil Engineering), flagship university development plan and why he started learning Chinese

By Anastasia KNOR, Anton CHEREPOK

SSTU is at another turning point. The oldest technical university in Samara Region managed to defend its independence, fortified its positions in chart, and entered the top of 11 flagship universities which, according to the Ministry of Education and Science of the Russian Federation plan, will become major innovation centers, drivers of economical development of their regions. During conversation with rector Dmitry Bykov we found out that SSTU is quite short of time for qualitative changes – nine months maximum.

For the university - with all my heart

Dmitry Evgenievich, there were all kinds of jokes and anecdotes about SSTU in Soviet era. Such as “If ‘good for nothing’ are you, welcome to SSTU”. How do you think, when this attitude changed, and when this university started being considered as a serious and prestigious education institution?

Within the university community and to a wider extent – in scientific and engineering communities – there never was any negative attitude towards SSTU: the level of our scientists never allowed that. For example, **Yuri Petrovich Samarin** for a long time was chairman of the regional rectorate board; founder of the Automation and IT Faculty, **Longin Frantsevich Kulikowski** trained a great number of major researchers in the field of automatics and measurement & calculation technology. But the attitude towards the university changed dramatically when **Vladimir Vasilievich Kalashnikov** had become the rector. He started managing SSTU in a very tough time: when salaries, even the lowest ones, weren't paid, and SSTU debts were increasing. Vladimir Vasilievich stabilized everything. Lecturers started to get paid double salaries, and SSTU got a sports centre, a pool, a camp in Chapaevsk, a cultural centre. At that moment, of course, people changed their attitude to SSTU as they saw that the educational organization had a great resource. Also, country demanded oil, and people strived into oil industry. 1000 freshmen joined the Oil faculty only! We got 23 full groups only for a single specialty! It was very hard, but at that moment we were doing our best to meet the market requirements by mobilizing all university assets. In fact, the Oil faculty had put SSTU into a good financial level then. Today, not only Oil faculty graduates but also other graduates are very successful and demanded at production. Labour market still requires qualified workers and engineers which graduate from SSTU.

There is an opinion that the higher education is conservative. It's not aimed for actual education, paying more attention to fundamental classic knowledge.

When I hear that our country lacks workers, I always ask: what kind of workers exactly? Modern worker who

operates a digital-programmed control machine should be able to program this machine, he should know all possible failures, all electronics. Does a college graduate have such kind of knowledge? Well, sorry! That's the kind of workers we lack. Speaking of those who can dig soil... Maybe we have plenty of them. Half of our graduates can design software, others can work with software. We've got a modern education, we train specialists who are able to work with the most complex equipment: Japanese, German, American.

And how do you modernize the teaching process?

We work with manufacturers, cooperate with companies which produce equipment and ship it to factories; we facilitate this equipment in our laboratories and scientific & technical centers. The Japanese allow us to make our own small software on their machinery, but they still own the machinery itself because the university can't afford one million dollars for it.

That's the technical aspect. And what about lecturers?

Each scientist, each lecturer (in the best meaning of this word) keeps learning through all his life. We read a lot, we spend huge amounts of money to get newest information sources from abroad. We watch what happens in the world and realize that we are more competent in some branches.

Such as?..

For example, in the field of coatings with very high magnetic conductivity.

Why then it's not on the market?

We are talking about purpose-made technologies. There is no open market for them. We will never sell them abroad: what was made in Russia, should work for Russia. But other SSTU technologies are well sold. Thus, we currently create new enterprise

in the university, “Association of Food Innovations”. There, we will do things that other world doesn’t. For example, edible food wrap film with very high mechanical characteristics. We brought the quality of these wraps to the quality of synthetic polymers.

You mean, that a cake can be eaten together with wrap?

Exactly. First you eat cake, then you eat its wrap which is also tasty.

You have mentioned that scientists are in the process of constant

We aren't strangers to each other

Dmitry Evgenievich, let's talk about recent events. Now, I guess, our minds are clear and there haven't been strong emotions and fuss on uniting three major Samara universities any more. How do you estimate this last-year conflict situation now?

This situation was considered as the conflict one only by society. In fact, it was absolutely normal process of searching new ways for further development of higher education in our region. We worked with the governor and discussed what would be the best. And in the end, we've got two united universities. Both of them are good. If we had been united



INTERVIEW

learning. What do you personally learn now?

You should always improve in languages. We have a comprehensive linguistic program. The rector and all vice-rectors speak English. Some speak two languages. We study permanently. It's hard to start, especially when you're older than 35. Now we have a Chinese language teacher, I started learning Chinese myself because China is our strategic partner.

Please say something in Chinese.

Wǒ shì xiàozhǎng (I am the Rector of university – author's note). Languages are compulsive, but not only languages. To be a rector, one needs a bunch of diplomas that confirm competence in the field of, let say, housing services and utilities.

with Aerospace (Samara State Aerospace University named after academician Korolyov, SSAU), it would have been hard to create a flagship university in the region.

Also, there were objective reasons to remain as two separate universities. Formally, because SSTU had low State exam score. In a united university, it would be below 70, and no one would guaranty to Aerospace to keep its positions in the S-100 project. **Nikolay Ivanovich (Merkushkin**, governor of Samara Region – author's note) realized it immediately. We couldn't take SSAU out of the project because it gives high profit for region development. And we found our own way, as we said. Everything else is only emotions. I think that the Oblast requires two strong educational institutions. Because it's good if there is some competition between them. Those are the rules of market and life. If one runs fast, another will also run faster. Just yesterday we had this image: since Samara is the space capital of Russia, somebody should build rockets, and somebody should provide launch for them! And we are, figuratively speaking, spaceport constructors.

Yet, you have initiated the uniting with SSUACE ...

Analysis by the Ministry of Education shows that interdisciplinary projects have been successful, and breakthroughs happen in the education institutions where number of students is over 25 thousand. It's not bad, it's world trend. Now we coordinate our positions with the Architecture University in diplomatic and steady manner. We should unite material and technical basis, find areas of common interest of the corporate cultures. People, thousands of students and lecturers are behind this uniting process. We never were strangers to each other, though. I worked in SSUACE for 8 years myself. I feel comfortable there, I come there like home. Now the home just became bigger.

Dmitry Evgenievich, even you, when misspeaking, still call the unified Samara University "Aerospace" meaning its main activity – training workforce for aerospace industry. But now this university has an "appendix" – Department of Humanities, with a, linguistic school in particular, which, in my opinion, many don't notice. In this respect, I have a question: what will be the priorities in unifying SSTU with SSUACE?

There will be an architectural and civil engineering institute inside our university, with its own individual account; it will have its Head in position of vice-rector. No one would lose anything. We will borrow something from SSUACE that we don't have. I must say, there work very decent people. I have already offered some of them key management positions. We've got Head of academic office and academic vice-rector from SSUACE. This is crucial. Our colleagues shouldn't feel like "younger brothers" or "poor relatives".

Different from others

How will the new united institution differ from the two existing?

In our flagship university development plan we set three tasks in front of us. The first one is to form the image of regional society. No more, no less. To change economics in general, one should change the person. You act as you think. One should start with thinking. The second task is to form markets of future. We intend to introduce a new method of project-oriented teaching of gifted students in interprofessional groups. Education process will be reformed, and, instead of traditional education plans, we should come to individual education trajectories aimed to form a team of specialists with unique interdisciplinary competence. And finally, the third task is to take control over the markets of the present. Our flagship university should generate a wide range of demanded educational products, to attract and concentrate the talented within the region, to make necessary conditions for their development, hence, for production and promotion of intellectual products with high added value.

How did the Ministry of Defense react to your plans?

Our university development plan is drastically different from all others. It's just located in another dimension. We have tried to show that there are ways that can lead to some real success, and no one has ever had such approaches to education like we do. No one. That's why we intend to attract third-party experts to the project implementation, the best Russian minds. I think that people will agree. It is announced

that the Ministry of Finance will provide a financial support. We will invest everything in human capital because the results should be given in a very short time.

How much time do you have? A year, two or three?

Eight or nine months. Next February or May, we will be asked: what are your results, fellas? Our results and the results of the other flagship universities will determine if the flagship universities plan will go on or will be cancelled.

Are there any results of such work already? What did you get rid of, what new did you get?



In my opinion, we – all our teaching and administration staff – got rid of fear that SSTU would lose its significance. We have considered our university as a significant educational institution of Samara Region. We got rid of feeling of instability. In order to get something, this feeling should have arisen. And actually, Nikolay Ivanovich was right. We all see it now. The university, as it was a year ago, is totally different from how it is now. We have won recognition thanks to our colleagues from the Architecture University. They had an opportunity to refuse a unification, and we wouldn't do anything. But the good will of SSUACE allowed to create a flagship university on our basis. It is very generous of them. They didn't care about themselves but about a forthcoming flagship university in Samara Region.

INNOVATION TEAMS

Interdisciplinary project groups were formed in SSTU



TOOLS AND DAYS
Prospects

In summer, SSTU hosted a competition of innovative projects which will result in competitive products such as technologies, experimental prototype or services. They will be created and promoted at market by interdisciplinary teams formed from talented students, research workers and experts.

57 projects were presented; they were offered by employees of regional industrial enterprises, by leading scientists and lecturers of Samara educational institutions. Ten of those were selected for further development, and two projects which got into competition short list were presented by industrial partners of SSTU, Novokubyshevsk Oil Refinery and Progress RQC.

Financing for the interdisciplinary groups activity is provided by the flagship university development plan until 2020.



Dmitry DEMORETSKY,
Doctor of Technical Sciences,
professor, head of the SSTU
"Technology of solid chemical
substances" department



Nowadays, explosive substances are used for oil and gas well perforation, for separation of complex technical system, material destruction, large-sized products stamping, material synthesis, etc. New breakthrough technologies in these fields will allow to increase the efficiency of military and civil use charges. Main consumers of the product being created, are MIC enterprises, geophysical and perforating equipment manufacturers, service companies performing oil well in order to intensify the oil inflow.

DOUBLE PURPOSE FIRING SYSTEM WITH AUTONOMOUS INTELLECTUAL CONTROL

The new designs of cumulative and frag firing systems with intellectual control have greater perforating capacity and increased hit area. Increased efficiency of charges is achieved by means of autonomous intellectual system for firing with a given space & time coordinates, with innovate layouts of perforating charges and new technologies of cumulative finishing on basis of high density materials.



AUTOMATED WASTE WATER PURIFICATION FACILITIES FOR DAIRY AND MEAT PRODUCTION

In food industry, waste water is purified by three stages: mechanic, physical-chemical and biomembrane. Coarsely particulate pollutant are extracted first, grease is extracted next. Then, colloid pollutants are removed, presumable, with reactant pressure flotation method. The final purification of dissolved and remaining colloid pollutants is performed with membrane bioreactor (MBR) which combines advantages of biological purification and membrane separation of purified water and active sludge. For MBR, individual micro- or ultrafiltration gradient-structured membranes are developed, that currently aren't produced in the Russian Federation.



Sergey STEPANOV,
Doctor of Technical Sciences, professor of ACI SSTU
"Water supply and water disposal" department



Purification of waste water in dairy and meat industries is a complex technical and scientific task. Existing sewage treatment facilities do not always provide purification level specified by regulations. The customers for new automated waste water purification facilities are food production enterprises and engineering companies.



Nadezhda MAKAROVA,
Doctor of Chemical Sciences, head of
SSTU "Technology and organization of
public catering" department



Edible food wrap films are biodegradable materials, they are safe for human health and possess barrier properties related to water vapor, gases and flavoring agents, providing structural integrity and mechanical properties of the products. Those wrap films can be demanded in environment with high transportation cost for food products: in space expedition, Arctic and Antarctica exploration, at offshore oil rigs, mountaineering expeditions, at submarines, in long-term travels.

FORMULATION OF EDIBLE FOOD WRAP FILM AND PACKING MATERIAL ON ITS BASIS

As a basis for edible wrap film, it is offered to use high-yielding fruit and vegetable raw materials from Volga Region. It will provide good organoleptic characteristics for the wrap. Also, edible wrap can be used for development of a package with antibacterial, antifungal and antioxidant properties providing longer storage for products without quality loss.



SOFTWARE & HARDWARE VIRTUAL REALITY COMPLEX AS A FOREIGN LANGUAGE LEARNING TOOL

Integration of the software & hardware virtual reality complex into the learning process is one of the new forms of teaching a foreign language. With it, a virtual reality simulator is implemented, allowing to simulate various situations in the professional area and the world around us. Thus, the language activity of students will be carried out in virtual reality.



Victoria DOBROVA,
PhD of Psychology, associate professor, head of SSTU
"Foreign languages" department.



Virtual reality technology and the teaching method which facilitates it, have an extremely high potential application. Software & hardware extended reality complex allows to increase quality and efficiency of language teaching. Introduction of this development will provide significant decrease of economic costs. Teaching with virtual examples will speed up the process of the linguistic material learning.



DEVELOPMENT OF GENE ENGINEERING IN ALUMINUM ALLOYS WITH FUNCTIONAL PROPERTIES AND CREATION OF THE PROTOTYPE FOR HELIOLITHOGRAPHIC LABORATORY FOR CONSTRUCTION AND SPACE PURPOSE OBJECTS 3D-PRINTING



Vladimir NIKITIN,

Doctor of Technical Sciences, professor, head of SSTU "Foundry and High-effective technologies" department; Anton Rakov, PhD of Architecture, associate professor of ACI SSTU "Innovative planning" department.



Molded details for heliolithographic laboratory of construction and space purpose objects 3D-printing will be manufactured of the developed alloys with use of additive technologies and reverse-engineering. Prototype of heliolithographic laboratory built in Earth environment will prove the possibility to use 3D-printing technology on the Moon.



Helolithographic laboratory is a robotic system which will allow to manufacture world's first artificial stone on the Moon surface. In the nearest future, production of artificial stone on the Moon surface will allow to build a stone protection for accommodation objects and infrastructure. Artificial stone will be used for paving of squares and roads on Earth natural satellite.

PROJECT TRAINING OF STUDENTS WITHIN TECHNOLOGY AND MARKETING ASPECTS OF PHARMACEUTICAL (S)-PREGABALIN SUBSTANCE PROMOTION

The developed technology is based on revolutionary new method of drug synthesizing with use of catalytic systems on basis of cheap and commercially-available non-precious complexes. Innovative technology will provide creation of (S)-pregabalin generic with the quality equal to its existing analogues, reducing production cost in 3 times minimum.

Introduction of pregabalin generic at Russian pharmaceutical market will allow to occupy up to 50% of Russian pregabalin selling segment. Annual generic sales volume in Russia can be estimated in 1 billion rubles.



Alexander REZNIKOV,

PhD of Chemical Sciences, associate professor of SSTU "Organic chemistry" department



Generic form of (S)-pregabalin neurotropic drug is used in treatment of epilepsy, neuropathic pain, general anxiety disorder and fibromyalgia.

INTELLIGENT SYSTEMS OF MONITORING AND MANAGEMENT OF TECHNICALLY COMPLEX OBJECTS

The basis of an intelligent system for the monitoring of long distance objects is a software and hardware complex that monitors the process of expected emergency situations using corrosion state results and piping reliability, in-tube and external defectoscopy results, field and laboratory corrosion-mechanical tests, metallographic studies of samples, results of technical diagnosing of the construction, as well as data of the technological parameters of the pumped product (pressure, flow, temperature). The developed technical solutions provide a quick detection of problematic situations at the object - leakage on pipelines with a liquid or gaseous product, unauthorized tie-ins to oil and gas pipelines, etc.

The mechanism for obtaining operational data for the needs of precision farming is based on a three-level monitoring system with taking photographs in different spectral ranges. This provides mapping using aerial and space images and identification of vegetation types and their stress state. To work with spectral information, they create "index" images based on a combination of brightness values in certain channels that are informative for crop varieties.



Nikolai GUBANOV, PhD in Engineering Sciences, Associate Professor, Dean of the Department of Automation and Measuring Technique, SSTU



Intelligent monitoring systems on a real time basis can be used to improve the safety of long distance objects, in particular oil pipelines. Also, the development will enable to obtain operational data for the needs of precision farming, to carry out remote monitoring and management of factors determining the efficiency of grain crop production.



Vadim SHIRYAEV, PhD in Chemical Sciences, Associate Professor of the Chair of Organic Chemistry in SSTU



In addition to the traditional approach to the search of new biologically active compounds, particular attention is being currently paid to the directed search for inhibitors acting on a predetermined biotarget. Having structural information, it is possible to use molecular docking methods for geometry modeling of chemical compound coordination in the active centers of proteins and to calculate the specificity of their action with respect to the predetermined protein target. For the effective new drug development, you need to explore great volumes of virtual connections. This determines the use of computer modeling methods for a priori creation of connection sets that optimally mirror the geometry of the active site of the target protein.

DEVELOPMENT OF THE SOFTWARE FOR THE NEXT GENERATION MEDICINES

The results of the project may be of interest to chemical and pharmaceutical companies. The obtained innovative product can be used for scientific purposes as well.

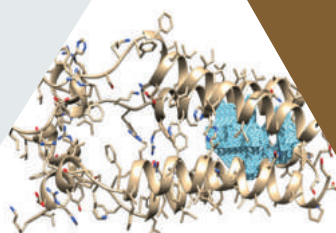



Pavel KUZNETSOV, Doctor of Engineering Sciences, Professor of the Chair of Electric Drive and Industrial Automation of SSTU, MSC "Progress"



Spectral methods which are relatively cheap and easy to implement in comparison with many other analytical methods are gaining increasing popularity. Spectral measurements are possible both with direct contact with the test material at the ground level (immersion and touch probes, field spectral radiometers and narrowband discrete scanners installed on the equipment) and remote sensing (hyperspectral sensors installed on unmanned aerial vehicles, man-carrying aircraft - laboratories and spacecrafts).

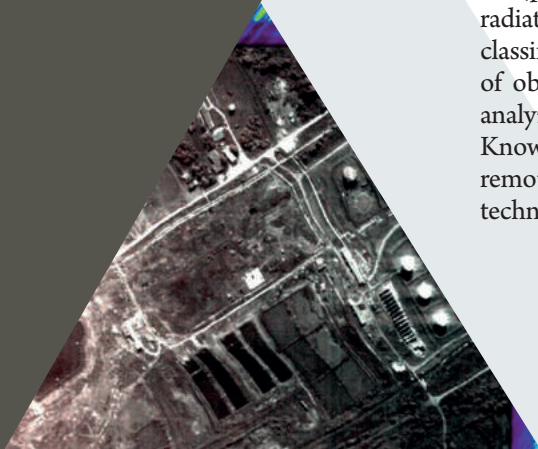

DEVELOPMENT OF SPECTRUM MONITORING INDUSTRY

The uniqueness of the hyperspectral equipment is that it provides electromagnetic radiation fixing in hundreds of most narrow spectral ranges.

During the hyperspectral survey a multidimensional image is formed where two dimensions characterize the spatial location of the terrain points, and the third describes their spectral properties. Every elementary part of the image (pixel) is provided with a spectral intensity of the radiation. The hyperspectral image provides a way to classify the observed objects in more detail. The possibility of obtaining spectral characteristics makes it possible to analyze the physico-chemical state of the observed objects. Knowing of these characteristics and the possibility of their remote registration provide moving to qualitatively new technologies for the image interpretation.



Alexey GAVRILOV, Deputy General Director for Development of JSC Novokuybyshevsk Oil Refinery; Alexander ILYIN, Head of the Project Planning and Controlling Administration of JSC Novokuybyshevsk Oil Refinery



ELOU-AVT-2 plant is designed for processing oil to obtain straight-run gasoline NK-80°C and 80-180°C, kerosene fraction, diesel fuel, vacuum gas oil and tar, as well as for reflux purification from hydrogen sulphide. The annual nominal capacity of the plant is 2 thousand tons and the run-life is at least 3 years.

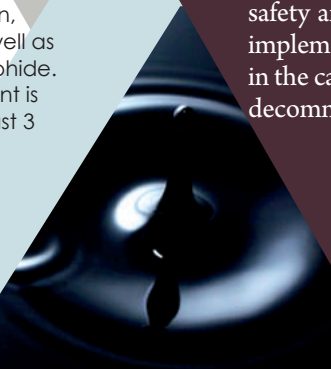

ELOU-AVT-2 COMPLEX AT JSC NOVOKUYBYSHEVSK OIL REFINERY

The newly designed ELOU-AVT-2 plant is located on the territory of the operating enterprise - JSC Novokuibyshevsk Oil Refinery. The plant includes an ELOU unit, a vacuum distillation unit with vacuum gasoil extraction (raw material for the hydrocracking complex under construction) 27% for oil and a unit for stabilization and rerunning of gasoline.

The project will develop the capacity for primary oil refining with the increasing depth of the vacuum gas oil extraction to increase the batch at the GC complex and increase the yield of light oil products. All the latest achievements in the field of technology, ecology, industrial safety and operational efficiency of the equipment will be implemented at the new plant. At the same time, an increase in the capacity for primary oil refining will be achieved after decommissioning of the inefficient and old AVT-9 plant.



RECYCLING INSTEAD OF WASTE DESTRUCTION

Samara chemists have created an industry of natural resource conservation

By Olga NAUMOVA

The main point of things

MADE IN SSTU

TOP NEWS 016

40

Waste recycling problem has been the urgent issue for several decades. Technological progress is followed up with environmental pollution caused by industrial waste and has reached a disastrous level in many Russian regions today. There are wastes or multi-component man-made formations in all areas such as automotive, aviation, oil, chemical, energy, food industries; public utility service; agricultural and even tourism and recreational cluster.

Waste composition has become more complex. There are some new compounds which are difficult to recycle with traditional methods and, as a consequence, they pose a serious risk to ecosystems. The issue of creating a qualitatively new approach to the analysis of the state of natural and man-made systems (complex of industrial,

municipal, agricultural, and natural objects) has arisen before the scientific community.

The team of scientists from Samara State Technical University has met that challenge. They have developed a comprehensive multi-level research system of man-made formations and have successfully introduced some new technologies of processing in dozens of Russian companies. This unique method of **recycling** includes multivariate data analysis of man-made structures and the chemical and physicochemical methods

Circulation of waste in "production - consumption" cycle

Identification Method of oil



ORIGINAL IMAGE

pollution of land

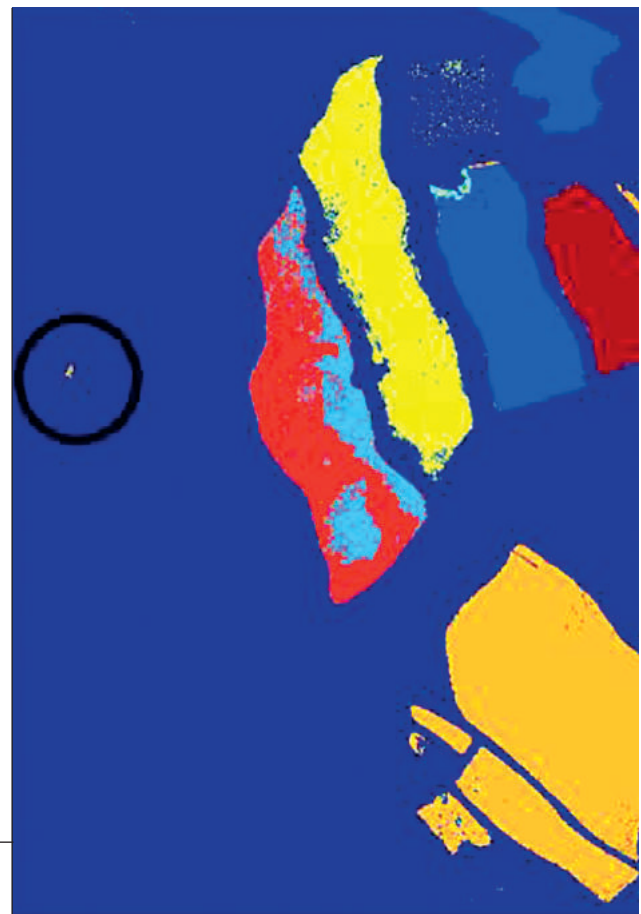

CLUSTERING RESULTS

(atomic absorption, **photometry**, etc.). Our scientists are experienced in carrying out monitoring and rehabilitation of territories polluted by oil, oil products and highly mineralized water.

Section of Applied Physics dealing with measurements of light

- To use regularities and methods of classical chemical technology to solve today's problems of chemical **remediation** is almost impossible, since we are dealing with complex multicomponent heterogeneous and heterophase systems. Most of them were formed spontaneously, - said Professor **Dmitry Bykov**, rector of Samara State Technical University. On the basis of his scientific school the foundations of chemical technological recycling in resource-conserving industry were created.

Cleaning, rehabilitating

Our scientists are in favor of recycling methods rather than waste disposal. They believe that the innovative process cannot start without evaluating the potential usefulness of technical and material value

of industrial waste components. An integrated approach allows researchers to establish and keep records of deep relationships between the waste origin, their quality and the applicable processing technology.

In particular, we are talking about wastewater disposal technology for a high degree of organic pollution, regeneration of paints and emulsions, recycling of polymer-metal waste, contaminated soil, sludge, drilling waste, sewage sludge and waste products of polyhalo-organic compounds, utilization of spirit bards etc. It is estimated that the Samara region has more than 10 million tons of sludge. During a 20-year period since the recycling technologies were introduced more than one million tons of waste has been processed at the leading enterprises of the region. The total economic effect from the introduction of recycling technologies has amounted to 2.5 billion rubles over the past 10 years.

For some years now, the scientific community has been talking about a recycling cluster in resource-conserving industry based on the concept developed by Samara chemists. Today, Dmitry Bykov's scientific school formed in 2001 at the department "Chemical technology and industrial ecology" of our university is represented by 5 Doctors of Science and more than 30 Candidates of Science. Of course, scientists from other cities like Moscow, St. Petersburg, Perm, Ufa and others are also

engaged in the problem of recycling but Samara scientists' work is perhaps the most effective.



Dmitry BYKOV, Rector of Samara State Technical University, Professor, Doctor of Technical Sciences, Honorary Figure of Russian Higher Education. Since 2001 has held the Chair of Chemical Technology and Industrial Ecology of SSTU. The author of over 180 scientific papers in the field of chemical engineering and industrial ecology, more than 20 registered patents. He is a certified environmental auditor, a head of the *Scientific and Analytical Center of Industrial Ecology and Independent assessment and methodical center "Eco Tech Safety" in SSTU*.

Dmitry Bykov was awarded the Euler Medal of European Environmental Academy. In 2005 - 2007 he participated as an expert in the joint program of UNESCO and the European Union " CABRI-Volga: cooperation and research on environmental risk management in the Volga river basin". In 2006 - 2007 Bykov was a member of the working group on improvement of the Russian legislation in the field of waste management of the Committee on Science, Education, Health and Ecology of the Russian Federation Council. In 2006 he addressed parliamentary hearing in the Federation Council on waste management and many of his proposals were included in the model law "On Production and Consumption Waste" for CIS countries.

STRUCTURE of intercluster chemical and technological recycling in resource-conserving industry

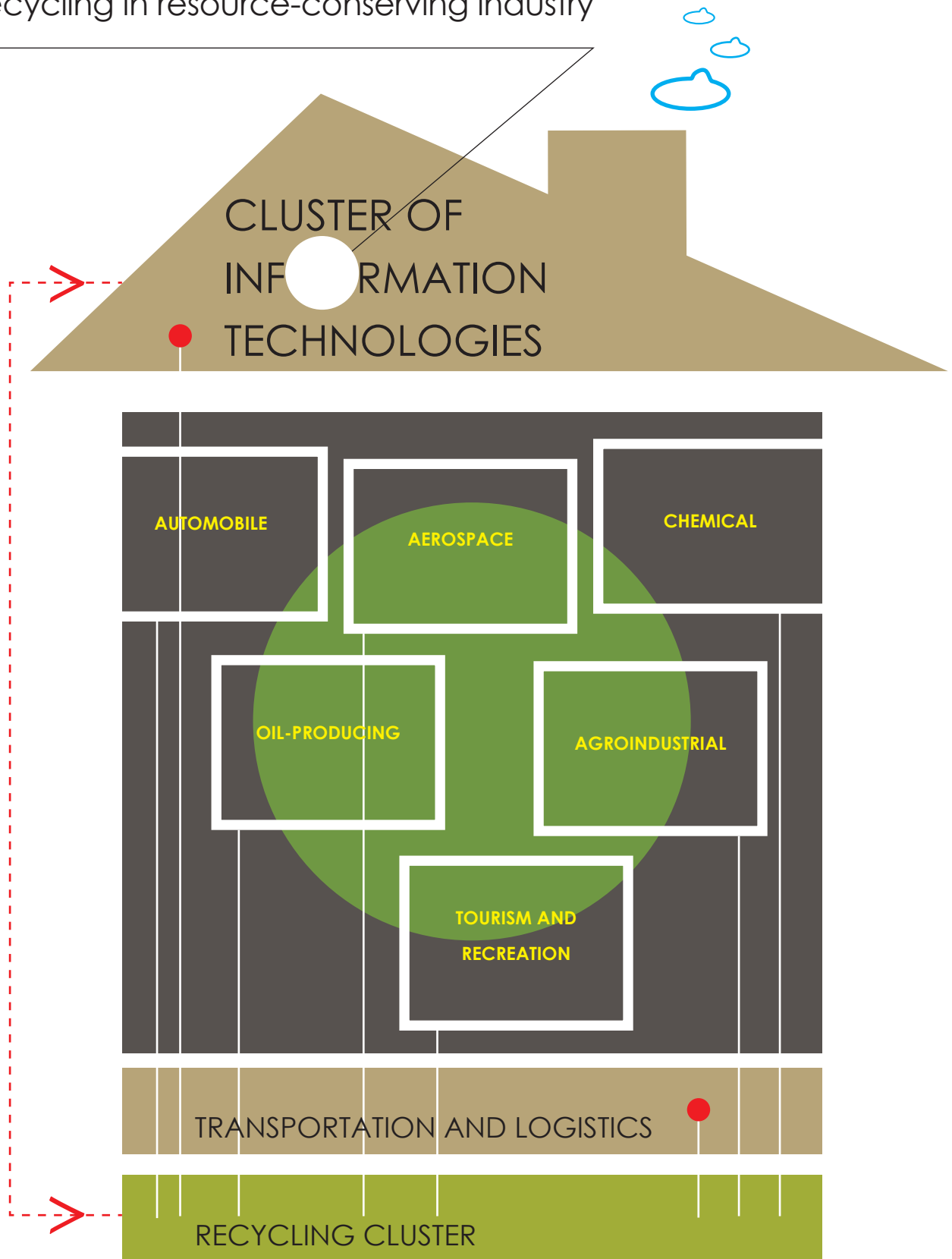

Recultivation work on land polluted by oil and highly mineralized water



Recultivation of oil pits





SCIENTIFIC AND ANALYTICAL CENTER INDUSTRIAL ECOLOGY of SSTU

Conducting chemical analyses of soils, waste, sewage and surface waters

Environmental audit of enterprises

Monitoring of the environment state in the zone of man-made objects impact

Development of environmental justifications for the activities of enterprises of hazardous waste management

Certification of hazardous waste, calculation of hazard class

Designing of landfills for industrial and domestic waste disposal

Scientific developments in the field of waste management improving

Ecological support of design documentation of construction objects

Accreditation and licenses for the relevant types of work. Maintenance of the coordination of the developed documentation in controlling bodies (Federal Service for Supervision of Natural Resource Usage , Federal Service for Surveillance on Consumer Rights Protection and Human Wellbeing , Russian Federal Service for Ecological, Technical and Atomic Supervision, Ministry of Emergency Situations, patent support)

1 Pervomayskaya Str., office 723, City of Samara, Russia

Tel.: +7 (846) 337-15-97.

E-mail:ncpe@mail.ru,

www.ncpe.samgtu.ru

BAKING AS A SCIENCE

Original recipes for bakery production are developed in SSTU

By Lubov SARANINA

MADE IN SSTU

Gastronomy

Bread is baked in SSTU. The University has all the necessary equipment such as a mixing machine, proofers, baking ovens. The recipes are developed at the Department of Food Production in accordance with the State Standard. Only the highest quality flour is used for baking.





Gastronomy



MADE IN SSTU

TOP DIGEST_2016

The right bread

Rolls and hot-dogs which are sold in the café of the building №7 in SSTU do not crumble or get stale toward the evening. Before selling baked goods the students identify basic physico-chemical parameters of the bread, as well as the “truthfulness” of the claimed composition of the bakery. They check acidity (which shows the freshness of the flour) , the properties of gluten, the dough moisture, the porosity of the crumb. For consumers it is a guarantee of the product quality, for students it is one of the laboratory works.

Second to none

Vladimir Bakharev, Doctor of Chemical Sciences, Dean of Food Production Department, and **Pavel Chaldaev**, Candidate of Technical Sciences, Associate Professor of the Chair of Technology of Food Production and Perfumery and Cosmetic Products has developed a unique fermentation starter based on ground oat with pure lactic acid bacteria cultures.

The obtained semi-finished product is used in the production of sponge dough and dough for bread and it positively affect on the taste and term of storage of the products. This bread can “live” for a day longer due to the bacteriostatic action of the fermentation starter made with spore-forming bacteria. The fermentation starter made it possible to get the products with higher physical-chemical and organoleptic quality parameters.

During the study the researchers could identify the benefits of oat processing products over the traditional wheat flour. It has been found that the products obtained by Bakharev have significantly increased content of useful components. Thus, the fat has increased by 117-134%, dietary fiber - by 13-33%, potassium - by 33-45%, calcium - by 33-46%, magnesium - by 155-176%, phosphorus - by 65-78 %, iron - by 46-54%. It was also found that the content of dietary fiber, phosphorus, iron, thiamine and niacin in 150 grams of product developed by the scientists is more than 15% of the daily requirement consumption. So, they are considered to be functional food products.

Scientific novelty of the work was noted and recognized in Moscow. This recipe is a unique one. The technology of bakery products made with this recipe was introduced into production in Samara Plant Bakery № 9. Scientists of SSTU also developed the recipe of bread with the addition of pumpkin puree and apple pomace powder which are additional sources of beta-carotene and healthy dietary fiber. These methods of bread making have been successfully used in the food production facility in SSTU.

Add a small amount of boiling water into the malt, stir and leave to cool for 30 - 60 minutes. Add the rest water with the temperature of about 30 - 35 ° C into the malt, mix and add all the ingredients beforehand mixed. Knead the dough and leave to ferment for 1.5 - 2 hours. Place a dough piece of spherical shape on a baking sheet, put it in a warm place for proofing for 40 - 60 minutes, the surface should be moistened with water periodically. Bake at 200 - 220 ° C for 30 - 40 minutes till golden brown skin.



The recipe of homemade wheat-oat malt bread

Wheat flour - 2 glasses
Oat flour - 1 glass
The rye fermented malt - 1 tablespoon
Salt - 1 tsp
Sugar - 1 tsp
Instant baker's yeast - 1 tsp
Water - 1-1.5 glasses



G ENIUSES OF SSTU

Young researchers of the flagship university develop promising innovative projects

By Eugenia NOVIKOVA

They say that science has no age limits. However, talented and committed young people in today's world often behave more energetic than established authorities. The potential of the youth and their scientific curiosity allow them to make breakthroughs in different areas such as electronics, mycology or oil production.

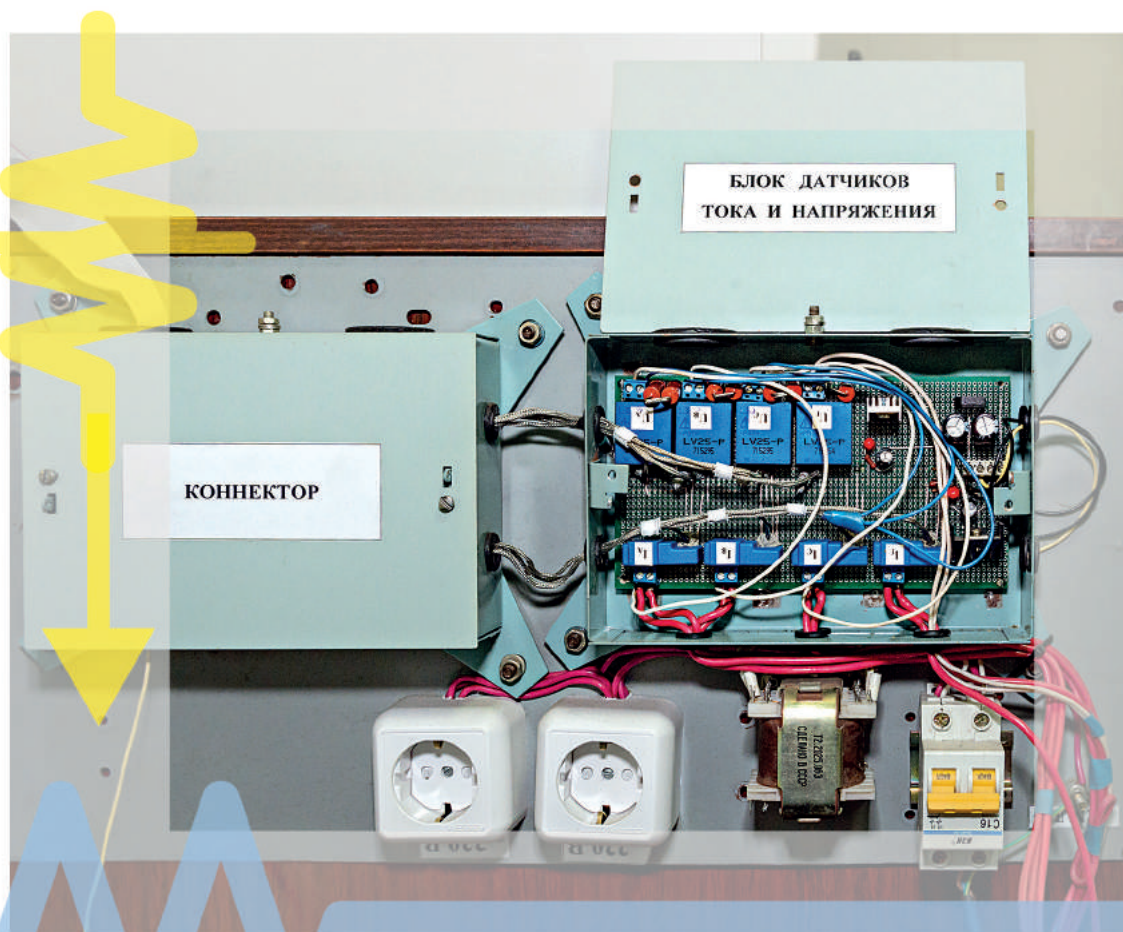

MADE IN SSTU Young science

Prevention of the fault

In September, a post-graduate student of SSTU **Michael Kritskiy** presented the monitoring system for the rotor winding of a turbogenerator at Kazan State Power Engineering University. He won first prizes at the XI Open youth scientific-practical conference "Scheduling and management in power engineering" and the VII International scientific-technical conference "Electrical energy industry through the eyes of the youth- 2016».

According to Michael, this is not the first, nor will it be the last, success concerning the development of

an advanced research topic he is conducting under the guidance of **Vladimir Polishchuk**, the head of the Chair of Power Supply of Industrial Enterprises.

- Last year we created a laboratory at university, assembled the installation which allows us to carry out the necessary experiments for the development of synchronous machines diagnostics system, - explains Kritskiy. - And we were thus able to increase significantly the number of publications in scientific journals and to participate in international conferences.



Michael KRITSKIY, a postgraduate student of the Chair of Power Supply of Industrial Enterprises



Age: 26 years



Research interests: electricity



Development: diagnostic systems of damages in synchronous machines



The problem they are trying to solve in the laboratory has been discussed at the sessions of the International Council on Large Electric Systems (CIGRE).

They try to diagnose the damage of the rotor windings in synchronous machines at an early stage. This problem concerns all areas including hydropower and nuclear power industries where the rotating mechanisms are used.

- In our country there are no installations for detecting the fault in the rotor winding when the unit is running, - explains Michael. - In order to diagnose hardly determinable damages, for example, an “inter-winding fault” in the rotor winding, the unit must be deactivated and disassembled which may lead to the undersupply of the power. We have made good progress in solving this complex problem.

These devices are being developed abroad but in Russia the alteration of a synchronous machine design is forbidden according to the rules for technical maintenance. In addition, foreign analogues having low sensitivity and selectivity do not identify the damage in time and thus can not avoid a large economic loss.

SSTU scientists updated the regular monitoring tools with magnetic intrusion detector which is mounted outside the unit. The final stage should result in a controller with the program based on intelligent techniques of digital information processing, enable to reliably diagnose the technical condition of the rotor winding in synchronous machines.

First, only Michael Kritskiy and Vladimir Polishchuk worked on this problem. They went to Togliatti and Syzran for machine components to assemble the installation. Soon some students of the Department of Electrical Engineering were involved in the research, and now the research team consists of nine people. Eventually, this innovative project was included in the final stage of the UMNIK program.

- When we create a prototype of the controller, we will participate in Generation S accelerator, - tells Michael about his future plans. - The topic is very interesting, and, perhaps, in the future we will need one more laboratory.



Pleurotus ostreatus, the **oyster mushroom**, is a common edible mushroom. It is often seen growing on dying hardwood trees, at home - on special substrates from plant residues. Mushroom caps with a diameter of 5 - 15 cm are similar to the shell, sometimes almost round, solid, at the edge thinner than in the center. Caps have a glossy, smooth surface. The color of the cap varies from gray or brown to ash-violet. The stipe is short (up to 5 cm long, 3 cm thick). Scientists draw attention to their health properties including high content of iron, kalium, zinc, phosphorus, vitamins B1, B2, D2 and the absence of saturated fats in the composition. Proteins of this mushroom contain amino acids such as lysine, valine, phenylalanine and threonine.

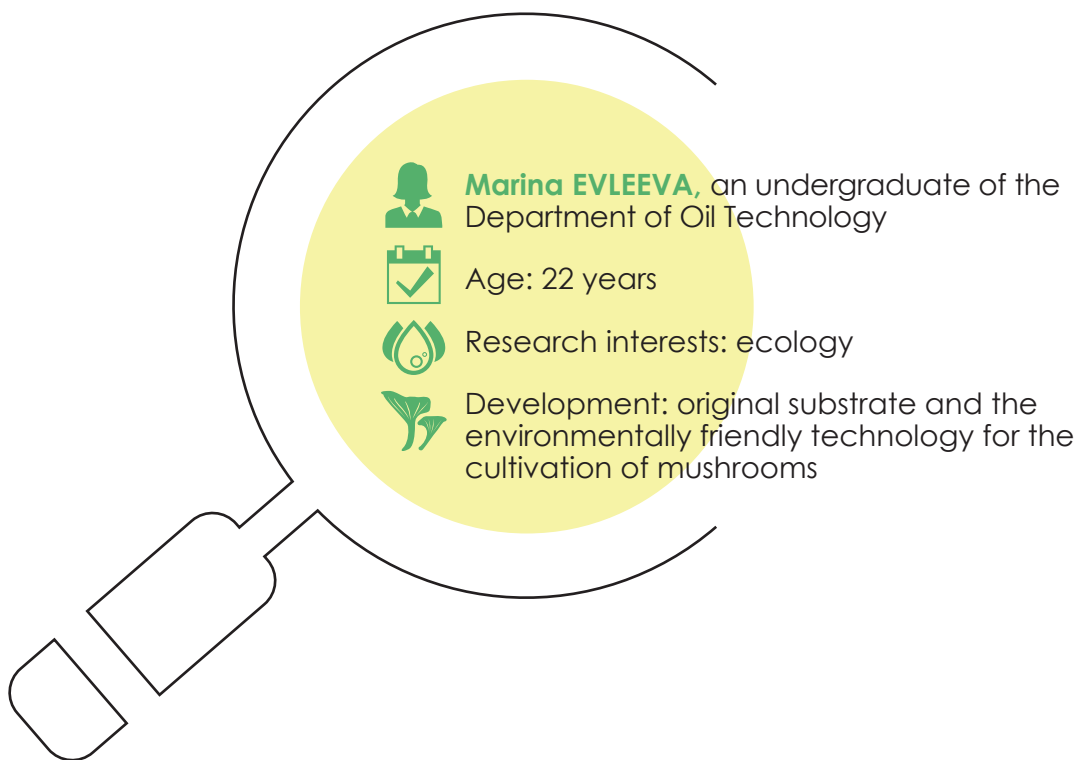

A good spot for mushrooms

A unique substrate and technology for growing ecologically clean mushrooms are being developed by **Marina Evleeva**, an undergraduate of the Department of Oil Technology in SSTU under the guidance of **Andrey Vasilyev** and **Vlada Zabolotskikh**, lecturers of the Chair of Chemical Technology and Industrial Ecology.

The research started last year and it has already drawn the attention of the experts of the UMNİK program and participants of Youth Forum of the Volga Federal District “iVolga”. At the Forum Marina’s project was included in the federal stage. Now she has a mentor from the regional Ministry of Agriculture and Food to help develop her future ideas.

The project is expected to issue two patents: on the creation of technological cycles for growing mushrooms available to farmers and on the substrate Eco food for mushrooms.

- We grow mushrooms without adding chemicals to accelerate growth in the ecologically clean area Pokhvistnevo, - says Evleeva. - The spent substrate is used as a fertilizer for the next batch of mushrooms. Thus, we have a closed cycle and waste-free production.

The new substrate will contain biologically active components. According to the developers, it will greatly improve the taste quality of the product and its useful properties.

- We are trying different mixes of natural ingredients such as husks of sunflower seeds, hay, straw, - says Marina.

In the framework of the project she has already gathered four crops of oyster mushrooms (about 20 kilograms).

- We chose the oyster mushrooms because they are easier to grow and their taste is better than, for example, field mushrooms, - she says. - Besides, oyster mushrooms are not so often seen on the shelves of grocery stores.

Marina has already developed a business plan for the commercialization of her idea. According to it the mushrooms can be offered in several variants. The first one is ready mushrooms grown in a special room, the second one is mycelium blocks of 2 and 8 kilograms to grow in the garden or even on the window sill in the house.

- We are solving the problems relating to import substitution, production of environmentally friendly products and the development of small agro-complexes on the territory of the Samara region, - says Vlada Zabolotskikh, a project manager, associate professor. - The results of the market analysis show that little attention is paid to the mushrooms cultivation in our area. We want to fill this niche on the market.

Professor Andrey Vasilyev added that an additional advantage of the innovative project is that it has already been tested. Mushrooms grow fast enough if there are favorable conditions.



Sergey GUBANOV, a student of the master's programme at the Faculty of Mechanical Engineering, Metallurgy and Transport, assistant of the Chair of Development and Exploitation of Oil and Gas Fields



Age: 23 years



Research interests: oil production, nanotechnology



Development: physical and mathematical model of the dual system of oil wells with periodic heating of the reservoir compartments

Analysis and synthesis

Sergey Gubanov is a member of the scientific team developing the project on the problem of the extraction of difficult-to-assess hydrocarbon reserves. Last year they obtained a grant from the Russian Science Foundation.

The theme of the project was chosen by Gubanov when he was a third-year student. His supervisor was **Valeria Olkhovskaya**, associate professor of the Chair of Development and Exploitation of Oil and Gas Fields.

- At the international exhibition *Oil production. Refining. Chemistry* in Expo-Volga I learnt about the technology of oxygen interbedding burning for oil production, - says Sergey. - I was really interested in this heat method and we started looking for a method of developing highly viscous oil fields which provide periodic heating of the formation.

Scientists of SSTU suggest solving this problem with the help of the dual system of boreholes using innovative physical and mathematical models. (Read more about this in the seventh edition of the journal "Technopolis of the Volga region" - author's note)

Gubanov conducts calculations to justify the increase in well flow rates during periodic thermobaric heating (heating under the pressure), calculates the effectiveness of the dual barrel system technology for specific fields. In collaboration with Valeria Olkhovskaya they have already published seven papers.

Sergey plans to write his thesis on the project's subject. But first he has to complete the master's thesis on self-propagating high-temperature synthesis (SHS) of silicon nitride and boron for obtaining ceramics on their basis. This study is conducted under the supervision of Julia Titova, associate professor.

According to Sergey Gubanov, SHS method is a very promising approach in modern powder metallurgy. The obtained nanopowders have unique properties.

- In the oil industry the equipment is subjected to various harmful influences or even easily damaged, - says Sergey Gubanov. - Parts produced from new nanomaterials can increase its turnaround cycle and operating life.



HIGH-RISE CONSTRUCTION 2017

International Conference
4 – 8 September 2017
SAMARA | RUSSIA

Dear colleagues,
We invite you to participate in the International Conference
«High-Rise Construction 2017» (**HRC 2017**).

Conference Venue:
Samara State Technical University,
Institute of Architecture and Civil Engineering,
Molodogvardeyskaya St, 194, Samara, Russia

Materials HRC 2017 will be published in full text in a
journal indexed by **Scopus**.

Conference Topics and Scope

- The Integration of High-Rise Buildings into the Urban Environment
- Typological Innovation of High-Rise Buildings
- Structural Design of High-Rise Buildings
- Engineering Systems and Technologies for High-Rise Construction

Participants and Speakers

Architecture / Urban Planning / Engineering / Materials / Technologies

- Architects / Engineers / Planners / Owners / Developers / Managers / Contractors / Suppliers / Academics / Research Workers / Press / Other

Conference Language • English/Russian

Registration and **paper submission guidelines** are available online
at scienceevents.net

Contact

scienceevents2017@gmail.com



PHENOMENAL REACTION

Scientists of SSTU department of Organic Chemistry promise to create cure for influenza and smallpox

By Svetlana EREMENKO

Many astonishing things happen in applied branches of organic chemistry today. Real breakthroughs on the cusp of chemistry, medicine and biology are about to occur, real results of development of science and engineering are obvious. Modern chemists must become not narrowly focused experts but rather interdisciplinary specialists; they should clearly realize what exactly the new chemical compounds are needed for. Even though the number of original elements the organic chemist works with is quite limited, they can build up the countless number of different combinations and molecular chains. When working on their breakthrough development, the SSTU scientists follow the general trend and win big grants to continue their research.

Force application

MADE IN SSTU

Fighting against influenza



Grant by the Russian Scientific Foundation

Subject: Target-oriented approach to the new ion-channel blockers of RNA-genomic viruses on the basis of cascade-structure compounds

In this case we're not talking about developing an advanced analog of the 'Grippol' vaccine which just eliminates the symptoms of influenza but doesn't actually cure the disease. We're talking about creating the real cure for influenza. Scientists all around the globe haven't created any pills, pulvis or mistura to deal with one of the most widespread virus diseases in the world so far. Neither those scientists who fight against hepatitis C can boast of major success. But people in the chemical laboratories

of various universities and pharmaceutical companies all around the world are still working hard on effective ways of beating influenza and hepatitis. And the SSTU scientists leave their colleagues far behind in some areas.

So we know that a virus can propagate itself only inside a living cell. Virus penetrates into the cell and use its genetic material to reprogram the cell's systems. Once the Samara chemists carefully studied the influenza and hepatitis C viruses they found these viruses affect the cells in relatively same manner. To be more specific, they both have protein structures (scientists call them a 'proton pump') which perform the same function that helps the virus to penetrate into the cell.

The SSTU scientists study the proteins that help to reveal the virus; they also study the structures that can neutralize the very 'pump'. As soon as they find a protein which helps the virus to penetrate into the cell, or a compound that neutralizes the 'pumps', pharmacutists will take over.

The way from careful operations with microscope test-tubes to creating the actual medicine usually takes a lot of time. But if the Samara chemists are lucky, their research will soon result in a molecule that will have all prospects of becoming a medicine. Especially because the scientists in the SSTU laboratories study resistant strains which have been circulating within the human population for a long time and which are resistant to many medicines for this reason – instead of working with conventional virus which mutates all the time.

Chemists versus smallpox



Grant by the Russian Scientific Foundation

Subject: Synthesis of low-molecular agents to retard the propagation of DNA-genomic viruses on the basis of structure-oriented design of polyedranic structures



The horrible disease – smallpox – was defeated in 1980 and this was announced at the World Health Organization assembly the same year. Its strains have been destroyed in every part of the world over the last decades. Today only two laboratories in the world – in Atlanta (USA) and Novosibirsk (Russia) – have the strains of smallpox. The strains are just stored there, and nobody touches them.

But there's still a threat that smallpox can be used as biological weapon, and the treat is real. What makes the smallpox virus especially dangerous is that if it spreads by airborne transmission – just like in case of an ordinary A.R.V.I. – death rate runs over 30 per cent. As far back as 1990's scientists managed to 'decode' the smallpox genome completely. So today the virus can be easily synthesized in every well-equipped laboratory. And there's no guarantee that smallpox won't be rescued from obscurity and used to attack the world where nobody is vaccinated against it – just because of political adventurism or banal human negligence.

Now Russia has neither the up-to-date vaccine against this terrible disease nor effective medicines that passed the clinical trials. The SSTU scientists became concerned with this problem and began searching for required molecular structures. The scientists are using modern computer technology when working on a new medicine. When the desired result is achieved, the research work will be continued by biologists and epidemiologists in secret laboratories. But there's one thing we know for sure – study of smallpox will never stop as all viruses constantly mutate.

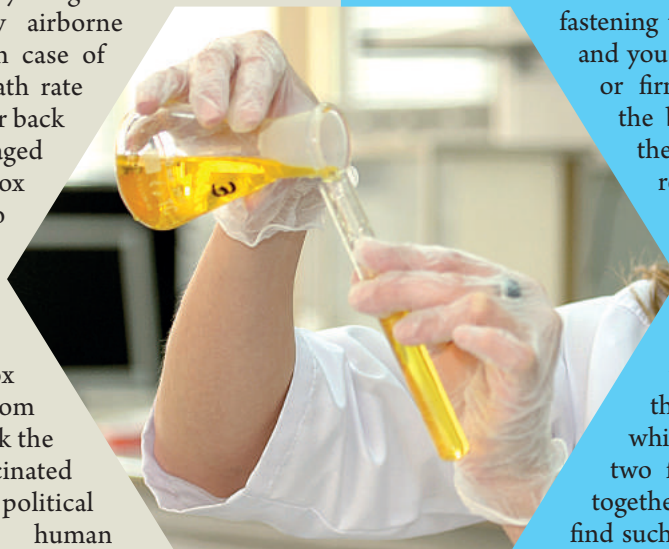

Click a molecule

Grant by the President of Russia



Subject: Polyannulated nitrogen-containing heterocycles on the basis of cascade and multicomponent reactions of ortoquinone methides



Academic community calls this method of finding new substances 'click chemistry'. Mechanism of the 'click' can be roughly explained as the following. Some chemical reactions run instantly. They can be compared with the click of the computer mouse button or fastening the safety belt: one 'click' – and you see the result on the screen or firmly lock the two ends of the belt. The main thing about these manipulations is that the reaction is inconvertible and it's practically impossible to put the things back on their initial positions.

The main idea of 'click chemistry' is that if we have two required reagents then the reaction creates a 'lock' which can connect two units, two ferments or two molecules together. Chemists' main goal is to find such substance A and substance B, the combination of which will always create a C substance – and nothing more.

'Click' reactions can 'sew' together big and small molecules – for example, proteins, dyes, vitamins – under almost any circumstances. Such type of chemical transformations is characterized by unprecedented level of selectability and reliability. This branch of organic chemistry originated from chemistry, biology and medicine. Achievements of 'click' chemistry find more and more applications in developing new medicines, studying their metabolism, creating new marks for cancer diagnostics.

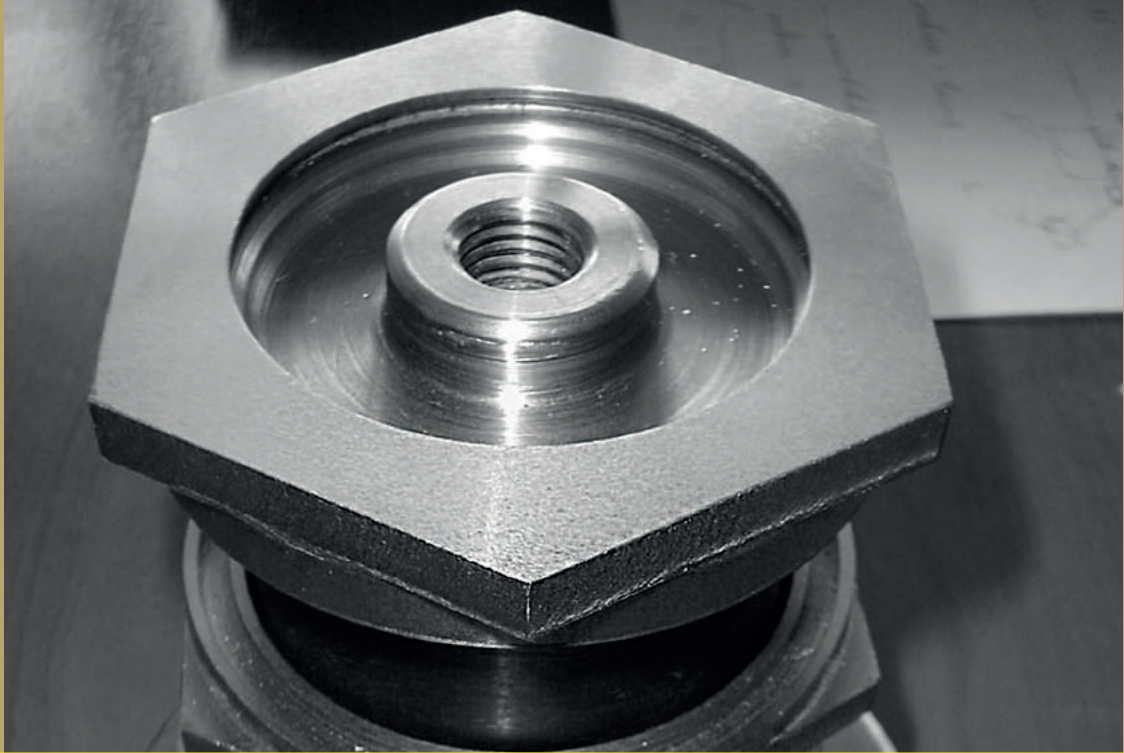

NO VIBRATION – NO HESITATION

SSTU experts know how to damp undesirable vibrations in complex technical systems

Transportation of oil, gas, chemicals and other highly hazardous products by pipelines pose potential danger. Among the factors that can cause an accident there are unauthorized incisions, natural corrosion and... vibration which occurs during the operation of compressor units and pipeline systems attached to them.

Gas air environment pulses inside a pipeline and it can cause significant vibration and lead to a great number of negative consequences: critical damage of parts, units and junctions, gasket leak tightness issues – all of which is inevitably followed by fire. Furthermore, constant mechanic noise and vibration blunts the service staff's attention, productivity and quality of labor falls as well; in addition to that, the above-mentioned factors are

hazardous for human health. **Andrey Vasilyev**, head of the department of Chemical Technology and Industrial Ecology, together with his research team come up with a number of improvements to solve these problems.

Mathematical models developed by our scientists and proper software help them to find the source and the cause of vibration of compressor units and pipeline systems attached to them; they also significantly simplify the calculation of distribution of gas vibration amplitude and vibroacoustic emanation in complex gas-transporting systems.

General-purpose antivibration mount with adjustable parameters of vibration damping

A unique design of this part employs the adjusting nut which changes the amount of damping, maximum operating load and static deformation of the mount. Rotation of the adjusting nut changes the effective

area of the damper. The improvement provides the high level of vibration isolation. As the result, the compressor unit is less affected by vibration so its reliability and operating life increase. Experimental testing of the pilot sample showed the 10 dB decrease of vibration.

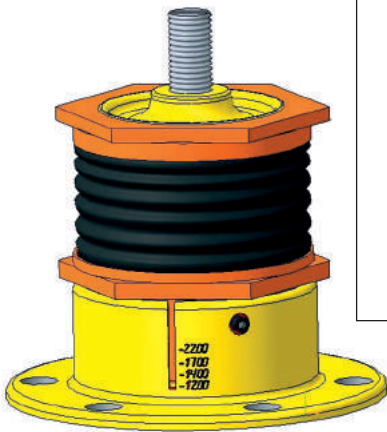

Vasily Efimenko, head of the equipment and facility diagnostics service at the Engineering center of 'Gazprom Transgaz Samara':

'Substandard vibration can cause the failure of pipeline transportation system and – in the worst case – technogenic accidents that negatively affect the environment (fire, CO2 emission, soil and water contamination with the substances transported by the pipelines).'
Great number of factors that affect the vibratory condition of the equipment – such as rotor disbalance, speed and pulsation of a substance being transported, pipeline configuration, mount system characteristics – make the task of lowering the operating machinery vibration quite difficult. One of the most effective ways to deal with heightened vibration of the equipment is to develop damping devices. Use of damping mounts helps to reduce the pipeline vibration significantly as well as to increase the reliability of the pipeline system operation.

Flexible absorbing mount

Andrey Vasilyev and his colleagues have developed and patented a flexible absorbing mount. Its advantages are the following: the mount is almost not affected by environmental temperature fluctuations, it is simple in production and operation, it is highly effective and technological. The vibration mount consists of two cramps – an internal one and an external one. One clamp is connected to a vibrating object and the other one – to a fixed base. The cramps are held together with a resilient

member; the latter consists of one or more corrugated sheets bent into a ring and put inside a cavity between the cramps. The cavity is filled with a viscous operating fluid (for example, mineral oil) and sealed with sealing rings from both ends. The whole unit damps the broadband space vibration of various types of machines.

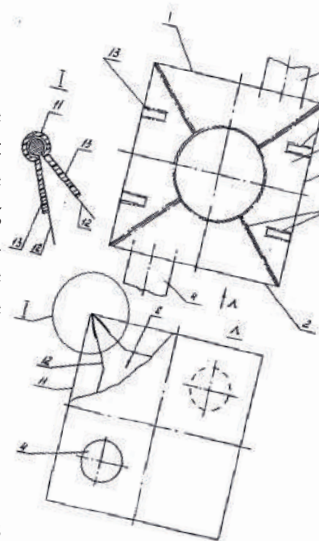

Hollow vibration dampener

This unit is a voluntary volume tank connected to a cylinder of a reciprocator by means of an outlet branch. Operation of the unit is based on use of a membrane made of a soft non-elastic material (e.g. cloth) able to sag. Calculation of mass of unit area of the membrane involves such parameters as its size, air density, length and cross-section area of the inlet branch which lets the atmospheric air into the tank.

As a rule, this type of a damper is installed on the suction manifold only because its application area is limited by relatively low excessive pressure of gas inside the manifold it's installed on.

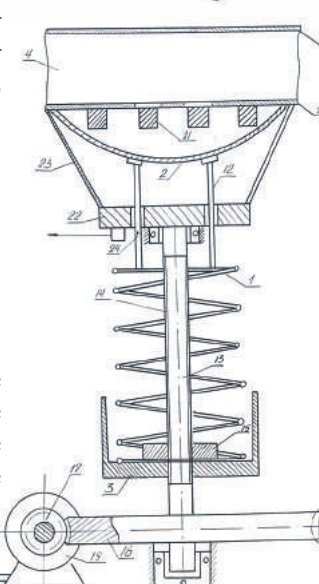

Spring-membrane dampener of low-frequency oscillations

Opposed to the above-mentioned unit, this unit is effective in a wider pressure range. In this case the unit is connected to the main line through the orifices in the pipeline and a light movable membrane which is hermetically hung in this area. A soft compression spring is installed between the membrane and a bottom bounding surface.

The unit significantly reduces the pulsation amplitude in the main line by converting the part of pressure pulse energy into the membrane and the resilient member pulse energy.

Engineering solution for a compressor

Technical improvements developed by our scientists and aimed at reduction of vibration of compressor units with pipeline systems were tested at the 'KuibyishevAzot' facility. Rigidity of the upper surface of the air filter was augmented by several reinforcing ribs welded to

the compressor; an additional mount was mounted and rigidity of the mount element was increased. These engineering solutions helped to reduce the compressor pipeline vibration up to 16 dB.

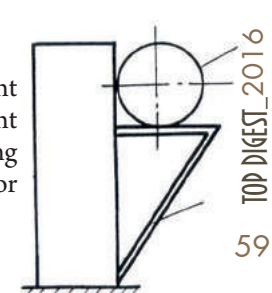



MADE IN SSTU Force application

A

CLUSTER OF DRONES

Scientists of SSTU know how to control the groups of autonomous aerial vehicles skillfully

By Eugenia NOVIKOVA, Ksenia MOROZOVA

Experts of the federal accelerator for technology start-ups Generation S in 2015 were interested in the development of the drone management which is conducted by the staff of the Chair of Electronic Systems and Information Security in SSTU in collaboration with the research and production company Network-Centric Platform. The team of scientists has already received some finances from the Fund for Assistance to Small Innovative Enterprises in science and technology for further research. They were also invited to become the residents of Skolkovo as the domestic aerospace cluster is interested in the implementation of these innovative and promising ideas.

“Negotiations” between vehicles

Unmanned aerial vehicles (UAVs) are actively used in various fields as they provide fast, economical and effective monitoring of any type of terrain. Winged robots have a lot of advantages that make their use almost non-alternative for rescue and military operations, for creation of accurate digital models of territories with a dense arrangement of various objects. Only the group of devices able to “negotiate” between themselves can obtain better results.

For manual operation of drones the operators are specially trained but they won't be able to manage effectively a large group of devices. That's why the real-time automatic planning and management tools for UAVs are more relevant than ever.

Researchers of Samara State Technical University offer the multi-agent technology and the network-centric approach to manage a group of drones. **Denis Budaev**, a project manager, explained that in multi-agent technologies the solution of a problem is a result of the interaction of many independent targeted modules, so-called software agents.

- In this case, the operator does not control the elements of the system but meets the challenge of goal setting, - explains Budaev. - He is responsible for task assignment and monitoring of incoming information.

To implement multi-agent approach in the management of a cluster of drones the device must have software platform that allows to run software agents and to exchange the messages between them in a physically distributed environment. In addition, each UAV must be sufficiently autonomous to act independently of the quality of communication with other devices and an operator.

An important component of the designed system is a distributed knowledge base that will store information about the current situation, sets of behaviors of the agents and algorithms for solving problems. Then, any change in the tactical situation registered by one of the members of the cluster will be fixed in its knowledge base and synchronized with the others. Each member of the cluster will be informed of important events such as the obstacles on the route, new targets or losses. This interaction will allow the cluster to respond to the event and adjust the plan of the assignment up to complete rearrangement.

Researchers of SSTU have thought everything over including the structure of hardware, interface and optimal scheme for planning collective actions of drones. Implementation of the developed system in the end will allow to share and use the unmanned vehicles for different purposes and design, to improve the efficiency of resource

management in real time, to increase flexibility and efficiency in decision-making in response to unforeseen events and to reduce labor costs of the operator on drone management.

“Vzhik-2015”

The UAV is of great interest for students' research works too. Last year a student of the

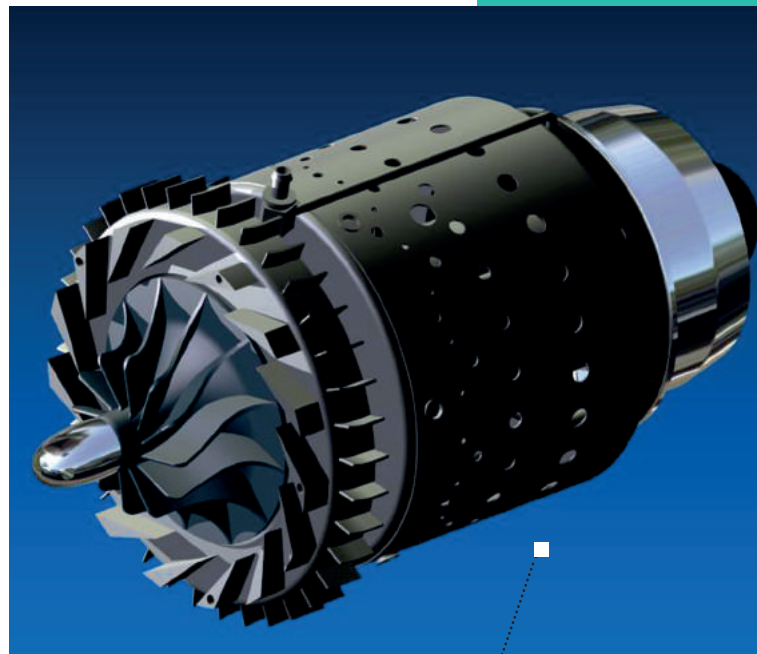

Department of Mechanical Engineering, Metallurgy and Transport **Alexander Titaev** became one of the winners of the UMNİK program and received a grant in the amount of 400 thousand rubles for the development of the current model of a jet engine for drones.

The engine designed by Titaev includes the analog control system. The **motor** will operate on three types of fuel: gasoline, kerosene and gas. The developer plans to provide the engine with a dual-circuit cooling system, a powerful electric current generator and an afterburner.

This device has already got the working name of “Vzhik-2015” for its fast speed and power. Now, an experimental prototype of the engine is to be tested in a special box at the checkout stand.

Force application

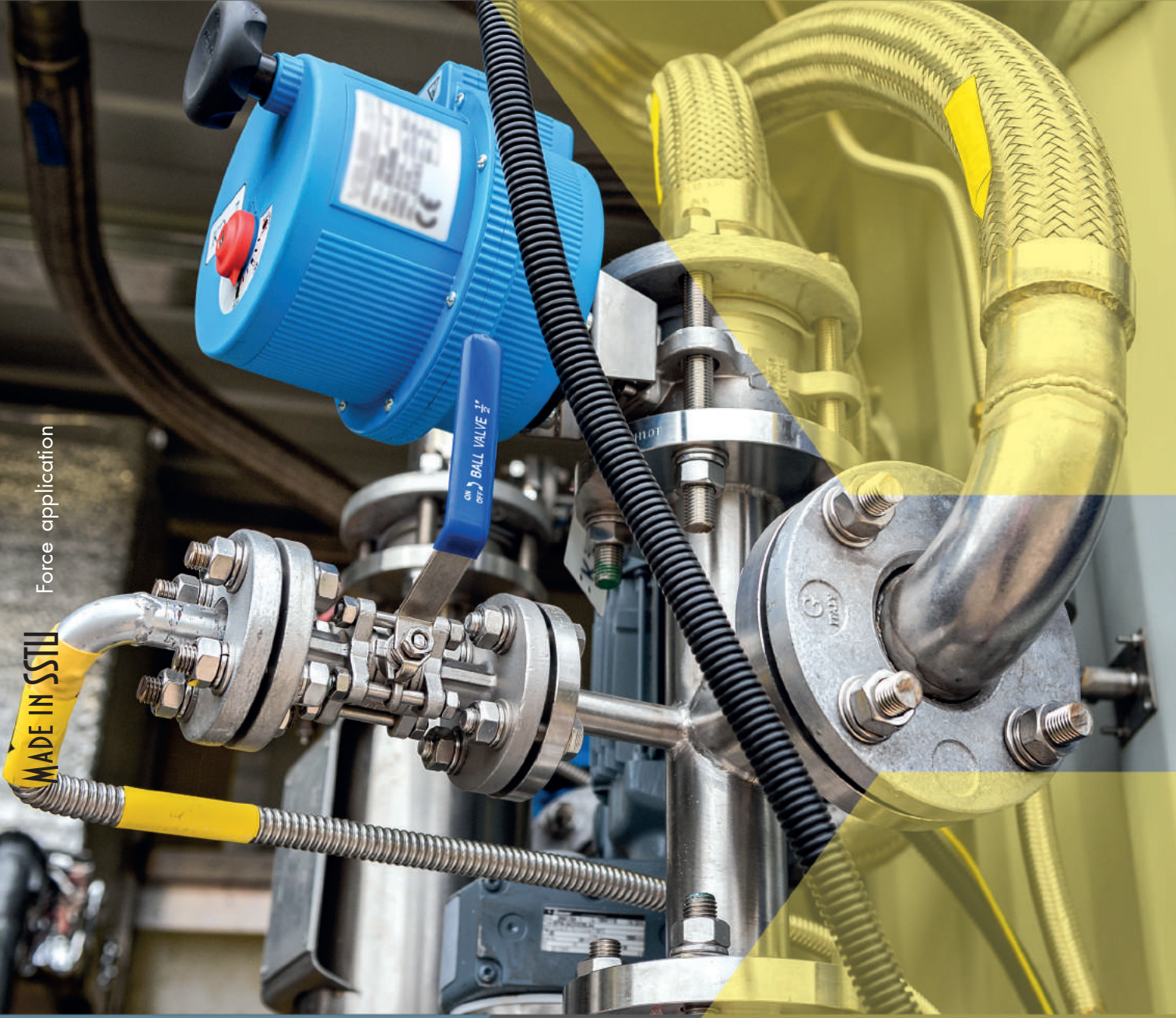

DEODORANT FOR ODORANT

The reason why the SSTU scientists ozonize
production tanks

By Svetlana EREMENKO



Industrial test of the world's first unit for the natural gas odorant disposal was successfully completed at the site of Sergievsk local operations and maintenance department for main gas pipelines of 'Gazprom Transgaz Samara'. The unit was designed and built by the site workers, experts of the scientific and analytic center of industrial ecology and the scientists of the 'Chemistry and Technology of the Organic Nitrogen Compounds' department of SSTU.

Smell of panic

Everybody knows that natural gas has no smell. That is why it is mixed with the artificial additives – odorants – that give the natural gas its specific smell and thus help to locate any leaks along the pipelines, in the gas holders, gas boilers and stoves. But on the other hand odorants pose a problem – each square millimeter of odorant-containing metal tanks exhale a disgusting, incomparable stench which must be removed before the tanks are put out of operation. Odorants contain mercaptan which appears in the Guinness Book of world records as the most evil-smelling substance on the

mercaptan left in the tank used to create panic among the local residents.

In a word, this problem remained unsolved for quite a long time until manufacturers asked the SSTU experts for help.

First-class reaction

The process of disposal and deodorization is based on oxidation. The SSTU chemical-process engineers developed the method for disposing of the odorant-containing tanks by using reagents. The scientists decided to use ozone as the optimal oxidizer. **Konstantin Shabanov** who took part in the scientific research as the head of the technical department of ‘Gazprom Transgaz Samara’ recalls that they had to develop the technology that hadn’t been known before:



planet, and people are extremely sensitive to it. Those who had a misfortune of smelling it say that it’s like rotten meat, burnt rubber, addled eggs and putrid cabbage with garlic – and all of this at the same time.

Until recently the tanks that used to contain odorants couldn’t be disposed in the common way as any other kind of scrap metal for two reasons. Firstly, odorant waste belongs to the 2nd or 3rd class of hazard. Secondly, the existing methods of treating the odorant with the chlorine-like solution cannot neutralize it completely. Some gasworkers recall that stench exhaled by the minute amount of

“It turned out that we had much work to do. We required a lot of interdisciplinary research in various areas of science and engineering.”

The SSTU scientists began their experiments with the 100 ml test-tube and eventually progressed to the actual high-tech innovative experimental-industrial facility that was approved by the state environmental expertize.

Poison is neutralized

Deodorization of the tanks is carried out in the following way. A tank is filled with a process medium and the ozone supply is turned on. The mix goes to the cyclone separator which splits it into the gaseous phase and the liquid phase; the gaseous phase goes to the ozone-destructing filter, and the liquid phase comes back to

Andrey PIMENOV, PhD of Chemical Sciences, head of the 'Chemistry and Technology of Organic Nitrogen Compounds' department at the Engineering-Technological faculty:

"Four years ago the officials of 'Gazprom Transgaz Samara' asked the SSTU scientists to solve the problem of neutralizing the odorant – a substance hazardous both for the humans and the nature - and deodorizing the odorant tanks. That is when we began developing the chemical reaction that would remove the odor and lower the substance hazard category."

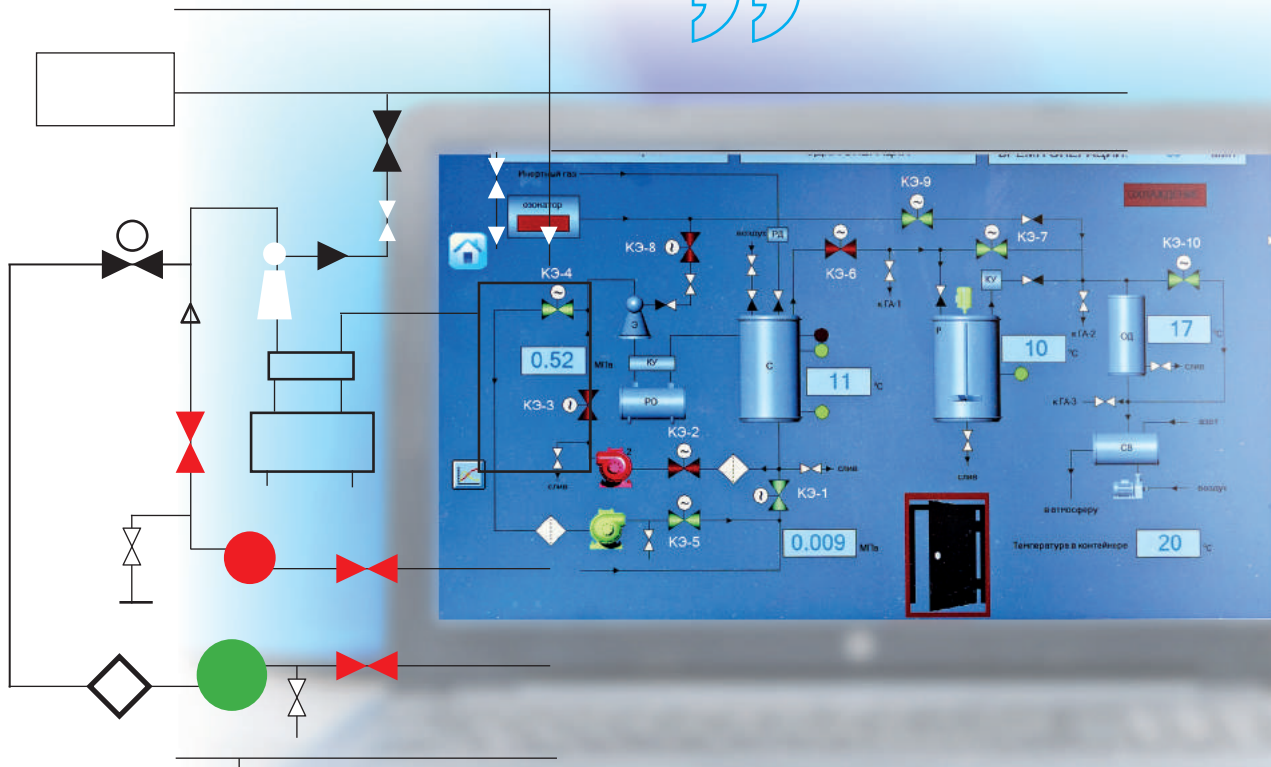

the tank. The key feature of this method is that the main process reactor is the tank itself. Such technical solution requires only one pump instead of numerous pieces of equipment. The process of ozone treatment produces the 5th hazard class waste (i.e. non-hazardous) and the process medium can be used again and again.

Pavel Krasnikov, a senior researcher at the 'Chemistry and Technology of the Organic Nitrogen Compounds' department of the SSTU, says that the tank deodorization time depends on the amount of odorant left in it. In average it takes one shift to treat one tank completely.

"Problem of deodorizing is wider than it seems. Presently 'Gazprom Transgaz Samara' alone has about 150 odorant tanks with capacity of one to five cubic meters," Krasnikov says. "We can only guess at the actual number of such tanks across the whole country."

Under the current regulations the operating life of the tanks for natural gas odorant is twenty years; after this period the tanks are to undergo the industrial safety expert review which shows whether the tanks can be used further or not. **Igor Vaskov**, head of the gas-main pipelines and gas-distributions stations operation department, says that

three or four odorant tanks are replaced at the 'Gazprom Transgaz Samara' facility every year.

"Until recently we had to send the tanks to the odorant-manufacturing plant. It was quite expensive. The unit developed by the SSTU scientists helps to solve at least two problems: we save money on transportation and disposal of the tanks and we also get the opportunity of using the unit right on the spot where we need it to neutralize the odorant because it is quite small and mobile."

"Development of the environmentally-friendly method for the odorant tank disposal solves the problem of waste accumulation and is able to prevent soil, water and air from contamination," says **Denis Neretin**, head of the environmental protection and energy efficiency department of 'Gazprom Transgaz Samara'.



NANO BLAST

The SSTU scientists developed modern technology of putting wear-resistance coatings

By Svetlana EREMENKO

The scientists in the SSTU laboratory of nanostructured coatings call the detonation coating their favorite achievement. This method of putting the coating employs the energy of gas explosion to heat and speed up the particles of metallic nanopowder.

Solution lies on the surface

One of the trends of the 21st century science and engineering is development of nanomaterial industry. Nanotechnology is used in solar batteries, medicines, fuel

parts and units are still unproductive, energy-consuming and ecologically unfriendly.

It is the quality of the surface that provides such basic parameters as reliability, technical perfection and competitive ability of modern technological and power-generating machines and means of transportation.

Today the most important parts of high-quality foreign machinery are always protected with wear-resistance coating. This approach becomes standard for designers and engineers, it's the indication of technical literacy and production standards because this special coating

Methods developed by the SSTU scientists have already been implemented by Russian manufacturing enterprises. For example, the SSTU-developed nanocoatings significantly increase the abrasion resistance of a drilling tool during its operation. And 'Electroshield-Samara' implemented the highly-efficient method of putting silver-diamond coatings onto aluminum contacts already covered with copper interlayer by means of detonation sputtering.

additives – in hundreds and thousands of mechanisms, things and substances around us. For example, particles of titanium dioxide repel dirt and thus can be used to create a self-cleaning surface. But while the nanopowder manufacture technology is quite worked out, the currently used methods for putting the nanocoating on

provides multiple increase of operational characteristics of products without significant financial expenditure.

Various metallic powders and composite filling compound are used for detonation method of putting powder coatings. The SSTU specialists justified that not only ceramic powder can be effectively used as composite filler, but also diamond powder (its particles are less than 100 nanometers).

Firing the gun

Suspensions and mixtures are crushed, mixed and blasted at the 'Roshya' training and production facility; there is a special experimental installation mounted there consisting of a gun and a reactor. Microexplosion is formed in the next-generation computer-aided detonation aggregate called 'Dragon'. Coating is put by the detonation gun – explosion products heated to thousands of degrees leave the gun barrel at enormous speed. During the explosion the particles go over the speed of sound; the speed may vary from 420 to 1300 meter per second depending on the gas mixture composition, and the temperature is 1500-2500 degrees Celsius.

Gas jet melts the powder particles and throws them at the part put in front of the gun barrel. Energy of explosion literally hammers the molten particles into the surface; it's actually microwelding and the powder strongly aggregates with the surface of the part at the molecular level. This method helps to achieve the uniform and dense structure of the coating – its properties get close to those

of monolith materials. In order to get the required thickness of the coating, shots are fired in series.

Harder than diamond

Over the years scientists have been experimenting with various alloys, cements and liquids; they have been adjusting such parameters as gas speed inside the camera, frequency and number of shots. Eventually they managed to develop a wide range of highly efficient protective coatings for various mechanisms.

“Let's take a look at a file – a simple tool known since the 12th century,” says **Albert Gallyamov**, scientist of the nanostructured coating laboratory, senior lector at the 'Machine-building technology' department, Candidate of Technical Sciences. “There haven't been any developments in the area of the file design and manufacture over the last 10 years. We developed a number of prospective and patentable technical solutions that improve the quality of files and, at the same time, reduce their prime cost. We came up with a new method of putting the abrasive layer on the grinding surfaces of this tool by detonation sputtering of hard coating – for example, a

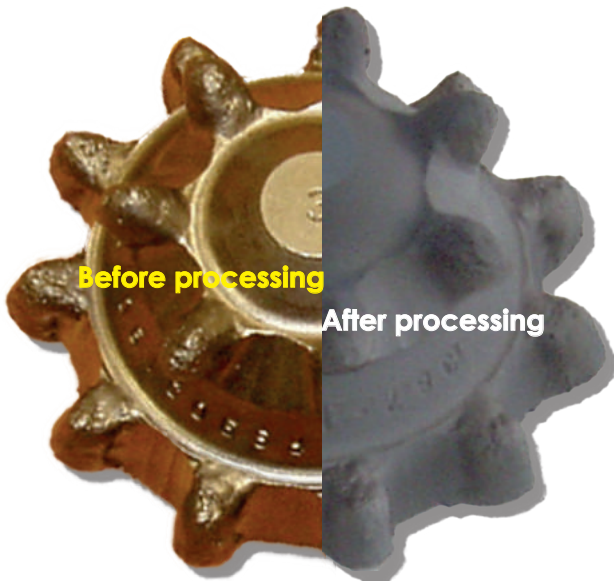

Functional diagram of detonation unit

- 1 – fuel
- 2 – inert gas
- 3 – powder supply
- 4 – ignition plug
- 5 – exhaust pipe
- 6 – oxygen

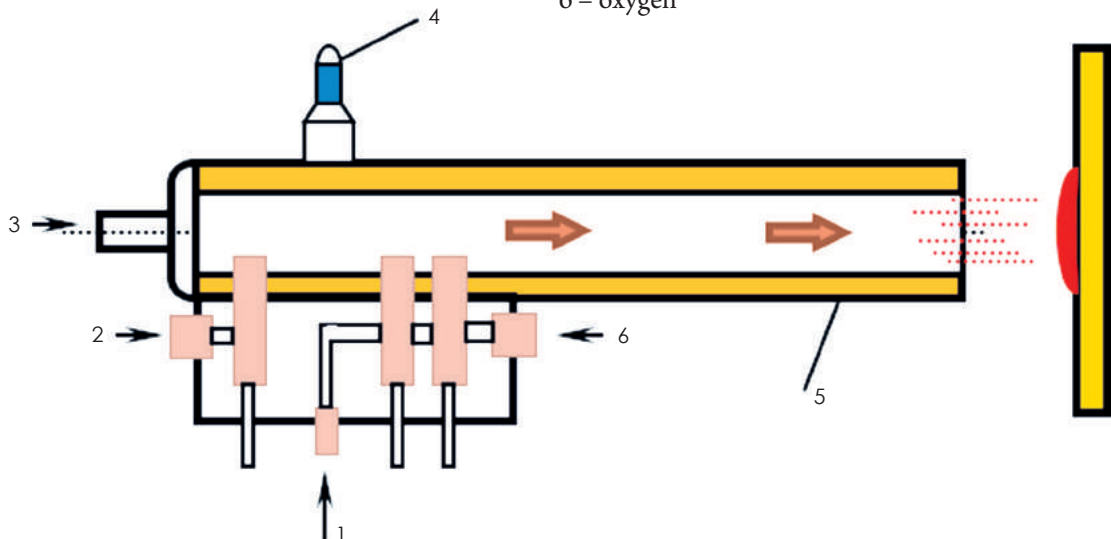

layer of rough hard alloy – onto the metal work piece. We can control the roughness degree by adjusting the size of the powder particles or the thickness of the layer being sputtered. The thicker the layer and the bigger the particles, the higher the roughness degree and, consequently, abrasive capacity of the file.”

Rate of detonation sputtering performed by the modern devices is up to 3 kilograms of coating per hour. At the same time, hard alloy coating is twice as hard as tempered steel. It all helps to produce a highly efficient abrasive tool. Besides, the files with such abrasive coating are more corrosion- and wear-resistant than conventional steel files, and more heat-resistant than the diamond ones.

Prototypes of these files have already been tested in the SSTU laboratory and produced good results.

The SSTU scientists also came up with the next-generation drilling bit. A sharpened rod with multi-layered detonation coating simply pierces metal sheets by heating them up to the melting temperature. It allows to speed up the drilling process and chase threads the thin-walled parts.

The SSTU scientists didn't stop at this and decided to make conventional lathe chisels and cutters cheaper as well. In order to do that they offered to cut metal with removable blades with hard alloy coating which can be easily replaced with new ones. This technology helps to save money on the tool and avoid sharpening of the blades as they are re-sharpened during the operation of the tool.

In 2012 at the contest of the best innovative and research and development projects of the year which takes place annually as part of the St. Petersburg Technical Fair the SSTU scientists were awarded with the diploma in the nomination “The best innovative project in the area of cutting-edge technologies for machine-building and metallurgical engineering” for their new technical solutions in the area of developing new metalworking tools .

Materials used coating

Iron, nickel, chromium, copper alloys, hard alloys (tungsten-cobalt), aluminum oxide, composite mixtures (iron-nickel, nickel-chromium and others)

particle speed – over **1000** meter per second

explosion product temperature – up to **4000** degrees Celsius

productivity – up to **3** kilograms per hour

size of the particles of the coating powder – **30-50** micrometers

thickness of the layer put in 1 shot – up to **15-20** micrometers

explosion product temperature – up to **4000** degrees Celsius

detonating mixture: acetylene + oxygen + special additive

maximum coating thickness (without intermediate treatment) ≥ **2** millimeters

Application areas

restoration of worn-out spindles

lifespan-enhancing treatment of land surveying and electrically-powered equipment

restoration and reinforcement of worn-out crankshaft necks

piercing dies for bearing retainers

lifespan-enhancing treatment of copper welding torch nozzles

development of a tool for plastic drilling of metal (making holes by rapidly heating the material)

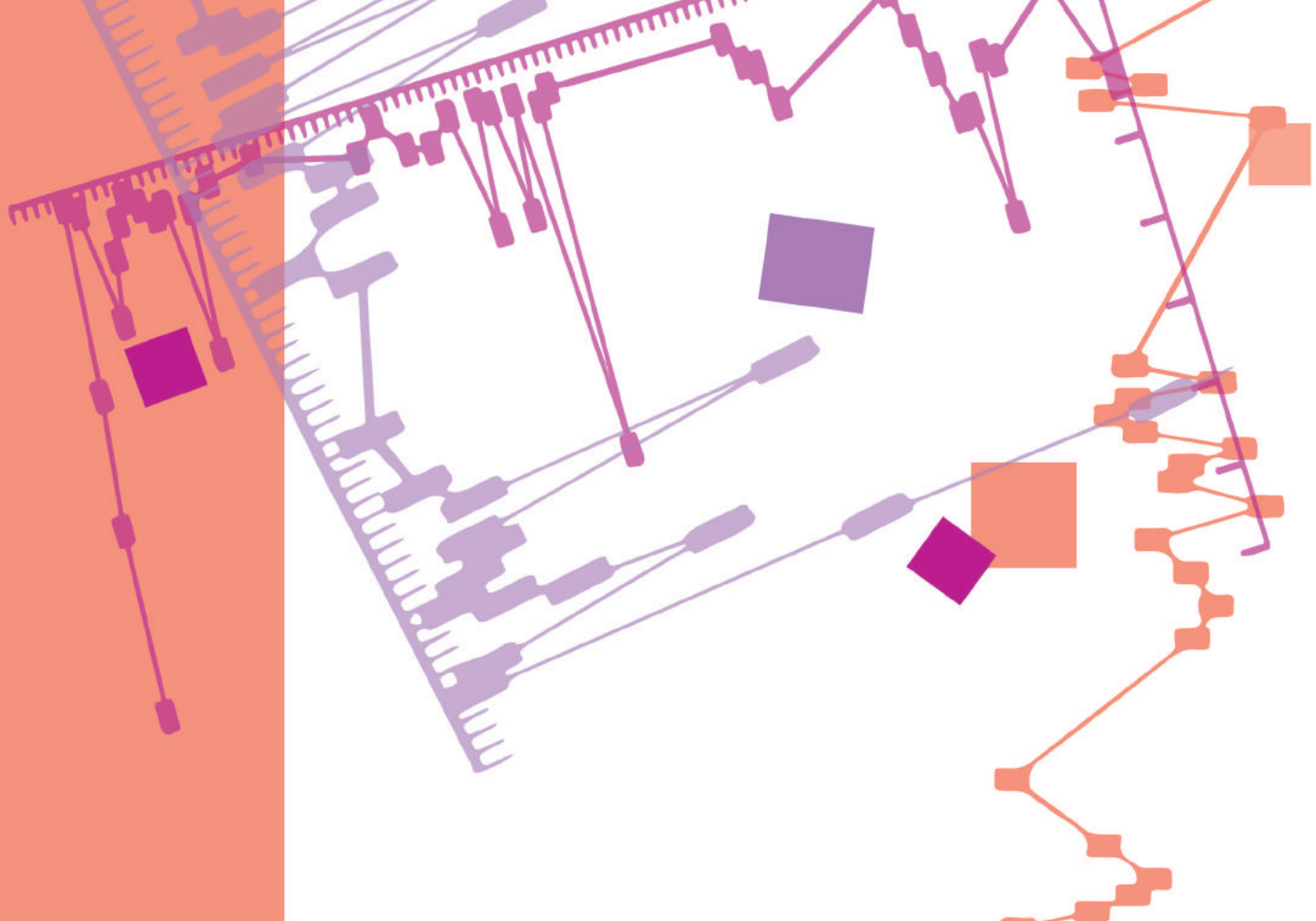

SLUDGE WAS GIVEN A CHANCE

The SSTU scientists developed modern technology of putting wear-resistance coatings

By Alexandra ISHIMOVA

When exploiting an oil and gas deposits, specialists of oil and gas industry require an accurate data on geological and physical properties of rock. With the lack of relevant information, well drilling may lead to complications and failure of expensive machinery. Precise data on lithofacial characteristics of drilled rocks is traditionally received by studying the core samples in laboratory environment (lithology is a science of sedimentary rocks, and facies is a complex physical and geographical conditions of the sedimentary rock formation, core is a rock column extracted from well with special coring drill – editor's note). To optimize the drilling process, SSTU scientists suggest to add sludge lithofacial testing results to the received data. Petromagnetic studies of sludge and core can be used a source of detailed information on magnetic properties of sludge and core.

In addition to the core

“Unfortunately, core sampling happens more and more rarely at drilling site, - says Alyona Morova, one of the developers of new method, senior lecturer at the SSTU geology department. – More often, when

preparing a project at deposit, sub-soil explorers have to hire an analog approach, making quite an inaccurate image of the real geological situation”.

At drilling, core can give a comprehensive information on rock, but it's not sampled enough. It takes months for specialists to process the material and conduct expensive analyses. But in reality they have to solve issues of high priority. The geological situation should be assessed

during the well drilling. Sludge analysis can help with this.

Unlike core, sludge – the remains of destroyed rock brought to the well mouth by drill mud – is always available, but many specialists treat it as wastes. However, sludge contains invaluable geological information that just has to be decoded.

“Surely, one can’t make conclusions on rock facies just by sludge, - Morova explains. – Sludge can’t replace traditional core testing methods, but it would allow to receive information on rock lithological structure”.

Two years ago SSTU specialists, together with colleagues from petrophysics laboratory of the Saratov State University, decided to apply a method of destroyed rock petromagnetic study additionally to lithofacial analysis of core and sludge. First results have already proven how successful this experiment was.

At the second stage, kappa metric (κ) and thermo kappa metric (thermo κ) petromagnetic studies (kappametria is a measurement of the magnetic susceptibility depending on para- and ferromagnetic minerals concentration in rock; thermokappametria is a measurement of rock magnetic susceptibility after thermal treatment) were conducted in the Saratov State University in petrophysics laboratory. For purposes of test integrity, results comparison was to be conducted after independent individual analyses in the laboratories of separate universities.

But it has already become clear at the preliminary assessment that the rock material amount is insufficient, and the

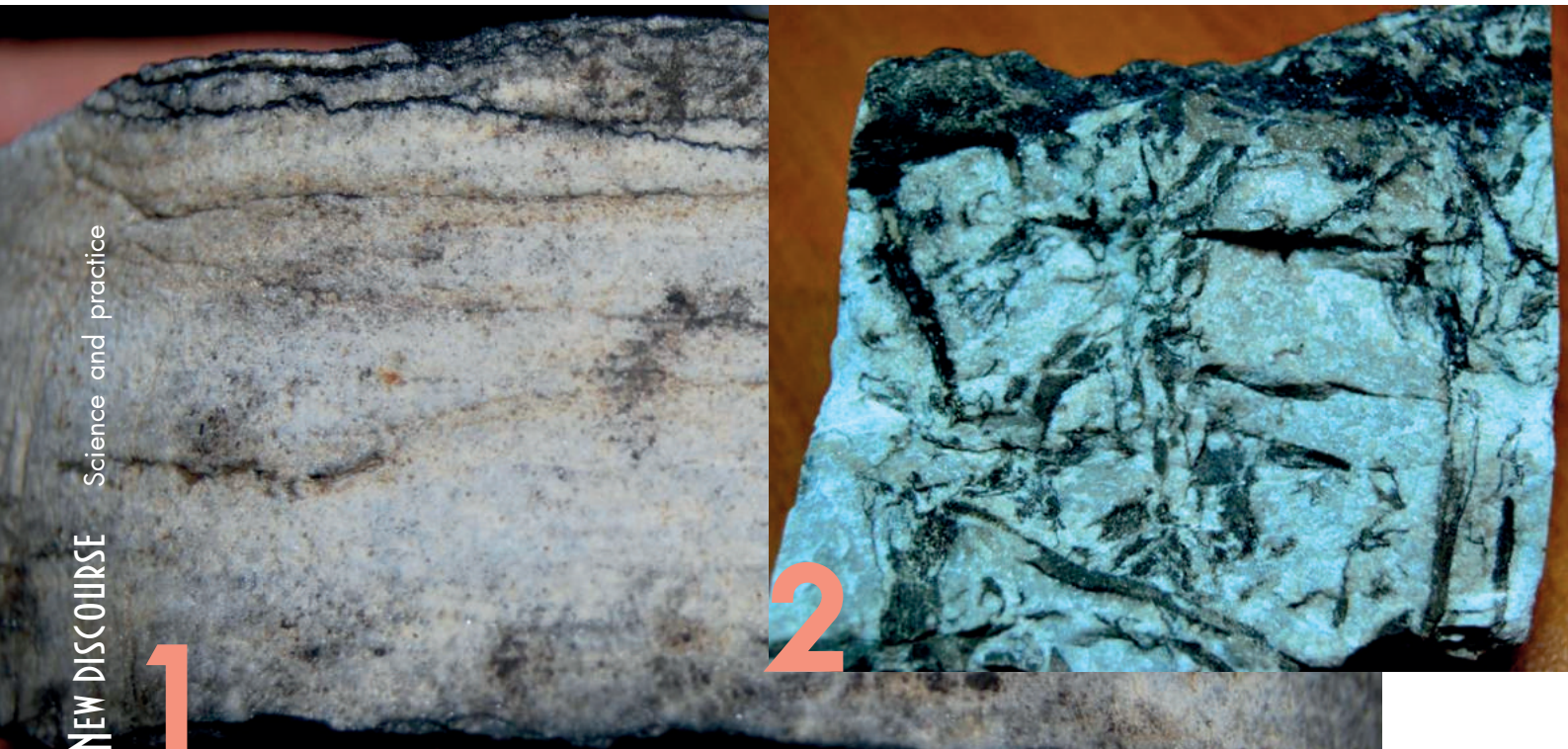

▲ Reservoir facies of Bobrikovsky horizon in Kovalevsky deposit:

- 1 – Marine sandstone
- 2 – Lagoonal sandstone

Magnetism principle

Scientists from two universities have come to a conclusion that the comparison of petromagnetic data with the results of lithofacial analysis not only helps to correlate complicated sections but also indicates if the rock is oil-saturated. It has become clear that such conclusion is a real discovery when the correlation scheme was developed for 14 wells in Novo-Kievsky deposit. Relation of the oil to a certain sediment genetic type was demonstrated during study of sediments at Bobrikovsky horizon in Kovalevsky deposit.

Due to lack of material and complexity of the given task, the beginning of the research was difficult. At the first stage, lithofacial analysis of core from two wells and sludge from four wells were conducted in the SSTU lithology laboratory.

material itself is of bad quality: sludge was poorly washed and sampled in five meter intervals instead of two meter intervals as stated in geological works regulations.

“I won’t work with this material! – exclaimed Andrey Guzhikov, SSTU professor, after analyzing the sludge delivered for study. – We will only waste our time and get no results”

Colleagues tried to persuade him: “Andrey Yurievich, we’ve still got core”.

“Now you’re talking. But I can’t guarantee anything”.

Despite of obvious inaccurate results, Guzhikov started working on this shady



▲ Core luminescence. Oil-saturated sandstone interval. Well No. 9. Blue core luminescence is typical for marine sedimentation sandstone (which indicates that there are no significant hydrocarbon clusters), blue-yellowish luminescence is typical for lagoonal sandstones (which indicates their productivity).

project. Samara geologist joined the work as well with enthusiasm, fulfilling their obligations.

The most interesting part started at the final stage. Comparison of lithofacial and petromagnetic testing data allowed to reveal a series of correlations, which helped to determine whether there are marine sandstone layers among lagoonal deposits in the section of each well. It was the lagoonal sandstones of Bobrikovsky horizon in Kovalevsky deposit which contained oil.

The so-called “layer cake” is located only in the upper part of Bobrikovsky horizon. In the lower part of the section, there are light sandstones with the best reservoir characteristics (they easily transmit liquids and accumulate them in voids), but, unfortunately, they aren’t oil-saturated.

Thus, having compared data received from a few well-known methods and having used a non-standard material to be considered unpromising (sludge) as an object of the study, geologist were able to make an objective assessment of the complicated geological situation at the deposit. New method appeared unexpectedly, and it was based on copybook maxims.

What's next?

Currently, a new laboratory is being designed in SSTU, equipped with kappometers – devices for measuring

the rock magnetic susceptibility. Scientists keep developing new testing method involving specialists from NPF STERH company. SSTU specialists are supported by Samaraneftgaz JSC and SamaraNIPINeft JSC. KogalymNIPINeft – branch of LUKOIL-Engineering LLC – is also following the development with great interest.

“It too early to introduce this method into production, though, - Alyona Morova assures. – In order not to defame the

Andrey Chipinskiy, CEO of NPF Sterh LLC:

“NPF Sterh LLC Scientific and production company have cooperated with SSTU geophysics and geology department for more than 5 years in the field of rock material study (sludge, core) gained in oil wells drilling. Our joint developments are used in practice. They allow to achieve a great level of detail of the sectional layering, to increase accuracy of geological navigation at hole boring, to increase operational efficiency when making corrective decisions”.

method, its testing should be performed by efforts of different institutes and production enterprises. When the geologist community will believe that the sludge, as well as core, is an invaluable nature data medium, the method will be widely used and become a reliable support for production workers”.

ANALYZE THIS

Original device for crude oil composition control has been created at SSTU Automatics and IT Faculty

By Nelya LEONOVA

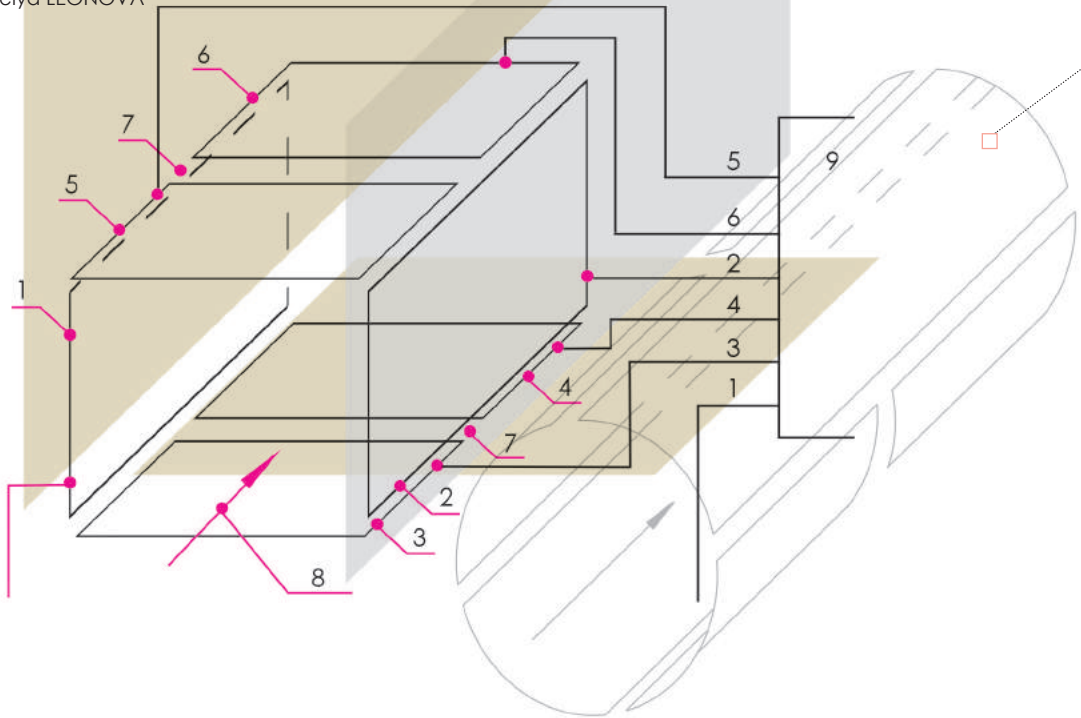

People don't actually think about the fact that the crude oil, extracted directly from well, is never "pure". Meanwhile, at oil production sites, machines pump out emulsion from wells – the mixture of oil and water, in which oil-associated gas is dissolved and various solid particles are presented. Those "additives" affect equipment at oil production enterprises, they cause corrosion and contaminate pipes and apparatus. Also, low oil dehydration and demineralization increase cost of oil transportation and ash content of saleable product – mineral oil and hydron. Operative control of extracted hydrocarbon crude water content allows not only to optimize the trade product preparation for transportation. Efficiency of further deposit exploitation depends on accuracy of phase composition measurements of oil extracted from well.

Water content measuring in SSTU fashion

Nowadays, there are various methods and apparatus for control of water content in production fluid. Many of them have disadvantages, such as dependence of measurement results on hydrodynamic structure

of multiphase flow, low efficiency of existing equipment with moisture values exceeding 60-70%, need for special calibration of devices for each grade of oil, impossibility to distinguish oil from gas in gas, oil and water emulsion, etc.

SSTU specialists managed to solve most of these problems in their developments, achieving accuracy and reliability in identification of extracted hydrocarbon product composition. Earlier, in 2010, Doctor of Technical Sciences, professor **Yuri Steblyov** and Candidate of Technical Sciences, associate professor of "Automation and process control" **Ekaterina Varushkina** patented a



method of electric capacity water content measuring in water-and-oil emulsion in flow, and also patented a device to implement this method.

The basis of this invention is **six-electrode electric capacity transformer** which allows

electric sounding of two-phase emulsion in various areas of controlled flow. During the control process, type of oil-and-water emulsion is identified automatically – “water in oil” or “oil in water”. Emulsion electric sounding is performed in different directions relative to flow direction in pipeline; moreover, both trough sounding of the whole flow and examination of its local areas are performed.

Besides the electric capacity transformer, SSTU oil-and-water emulsion composition control device contains commutation block with seventeen controlled electronic keys, five-channel “capacity-voltage” transformer, analog multiplexer, programmed booster, timer, controlling signal former, reference voltage source, analogue-to-digital converter, microprocessor, data registers and addresses, ROM and timed pulse oscillator.

Promising device

This invention was not only about getting a patent. Soon, associate professor **Sergey Susarev** joined the research team and, together with his colleagues, developed new hardware and software complex for full-flow control. Then, it came to the creation of prototypes of computer-tomographic multiphase flow analyzer.

“The very first device model was constructed at the department, - Susarev recalls. – Some elements and casing had been manufactured by custom order at industrial enterprises. Electronics were our own.”

Finally, they made a **small device which is built in into pipe** and contacts the flowing emulsion. The device transfers information to the control system which determines percentage of water, oil and gas in the production fluid.

Content of deposit water in water-and-oil emulsion extracted from well can reach 80-85%. The standard states that mass fraction of water in oil prepared for transportation must not exceed 0.5-1%. Dehydration at oil production is performed with a unified oil processing unit. After delivery to a refinery, oil is dehydrated again, reducing the water content to 0.05-0.1%.

Each time when SSTU researchers demonstrate the computer-tomographic multiphase flow analyzer at exhibitions, the device attracts intense interest of specialists. In 2011, the inventors won the qualifying stage of all-Russian competition of students, postgraduate students and young scientists works, “Eureka” (Novocherkassk city); in 2012 they got a silver medal at 40th International salon of inventions in Geneva; and in 2013 they were awarded with silver medal at Saint Petersburg Technological Fair.



There are similar inventions of foreign scientists, by they are quite expensive. According to specialists, foreign counterpart of such analyzer costs about five million roubles, while SSTU device costs five hundred thousand roubles. Analyzer developers count on project commercialization because there is a demand for such device already.

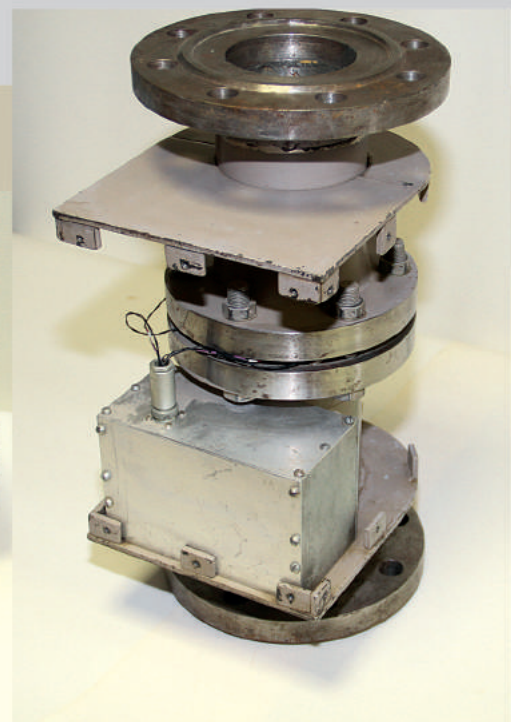
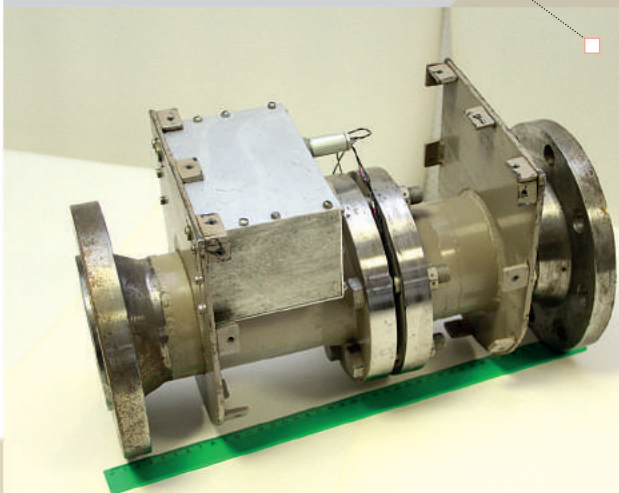

SHOW ME A MOON STONE

The Moonsettlers' dwellings will be 3D-printed

By Svetlana EREMENKO

There are some reasons to believe that the opportunities for builders and architects to participate in the Moon exploration can be significantly reconsidered soon. SSTU launches the project to create artificial moon stone.

NEW DISCOURSE
Prospects

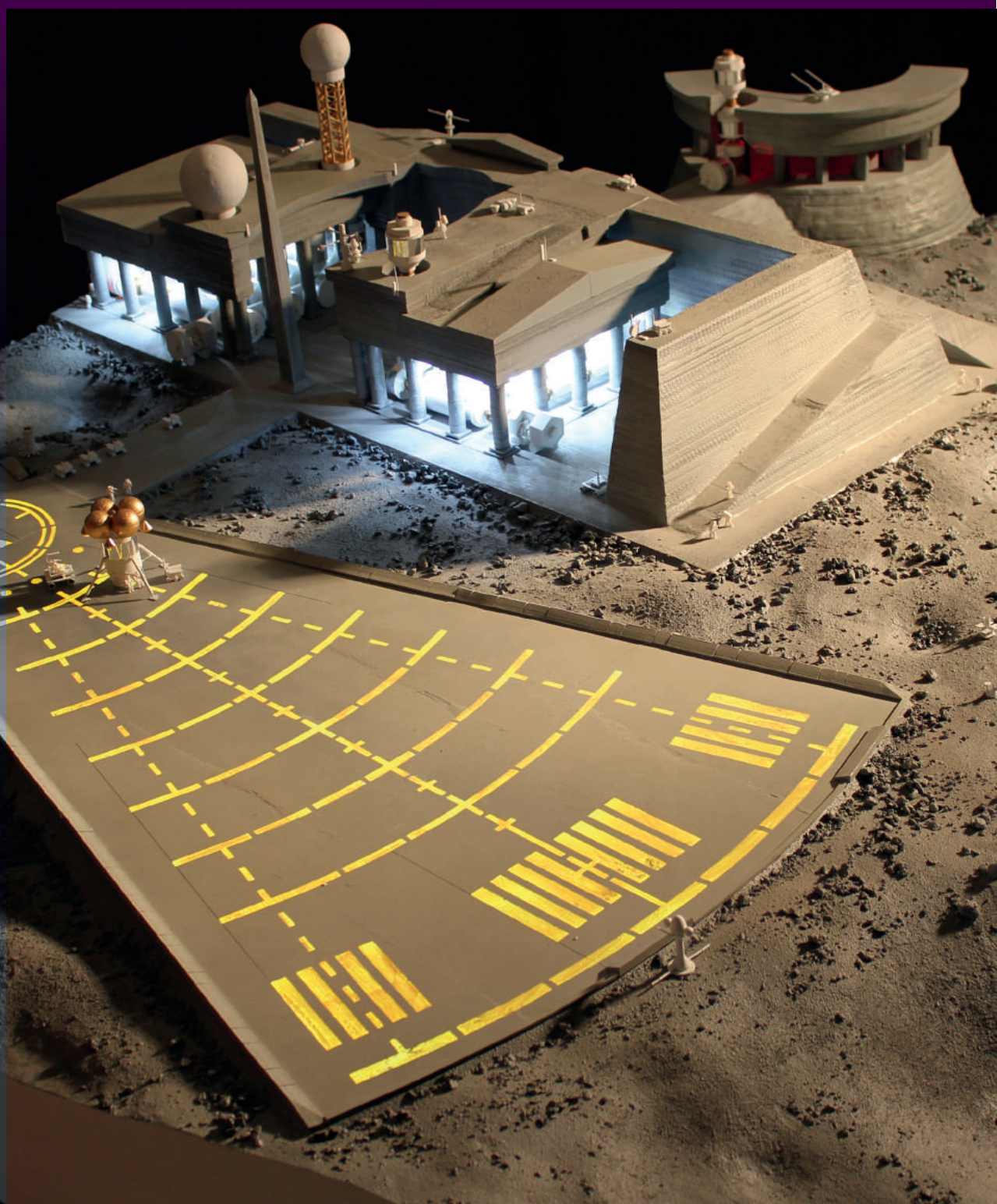

The Moon as a construction site

The Moon is the first 'interchange station' on the humankind's way to outer space and an undeveloped depository of resources. Beneath the surface of this lifeless (as seen from the Earth) planet there are deposits of iron, titanium, aluminum, magnesium, sulfur, potassium and sodium. And on the surface there are deposits of very rare helium III isotope which can be used as safe fuel for the thermonuclear reactors. Besides, the Moon (which is only a three-day flight from the Earth) has ice

formation which means that there are water deposits there as well.

Space industry has developed over the years and the problem of colonization of the Earth's only satellite becomes solvable. And the earthmen themselves are ready to become the first Moonsettlers. But before they successfully 'move' to the Moon they need to build a permanent base there.

In **2014** 'Roskosmos' and 'Rosatom' approved the project of the Russian lunar mission which consists of three stages:

2016 – 2025 — stand-alone stations identify physical and chemical properties of the lunar soil and specify the precise amount of water deposits on the Moon.

2028 – 2030 — manned flights to the Moon.

2030 – 2050 — construction of the habitable base and the mining operation site.

Building a settlement in the extreme lunar environment means solving a number of major problems. For example, constructional material becomes a very important issue as it's needed to build the accommodation, laboratory and manufacturing modules. Carrying 'bricks' to the celestial body which is almost 400,000 kilometers away from the Earth is very expensive. It means that the required construction material has to be found on the Moon itself. Scientists, engineers and architects agree that the lunar soil itself—regolith—can be used for this purpose. Structures made of bags filled with moon dust, selective laser sintering of regolith, inflatable structures... European and American scientists considered numerous opportunities and came to unanimous conclusion that the most reliable and effective way of building the lunar modules is to print them on the 3D printer. It's the best decision in terms of vacuum, high background radiation, daily temperature difference of more than 200 degrees Celsius and constant micrometeorite attack.

Sun is our mason

Today the 3D printers not only make single parts for every kind of machinery but also construct the entire buildings. Efforts taken to apply this technology to the construction industry are well-known. For example, Marcus Kaiser's printer called 'SolarSinter' creates 3-dimensional

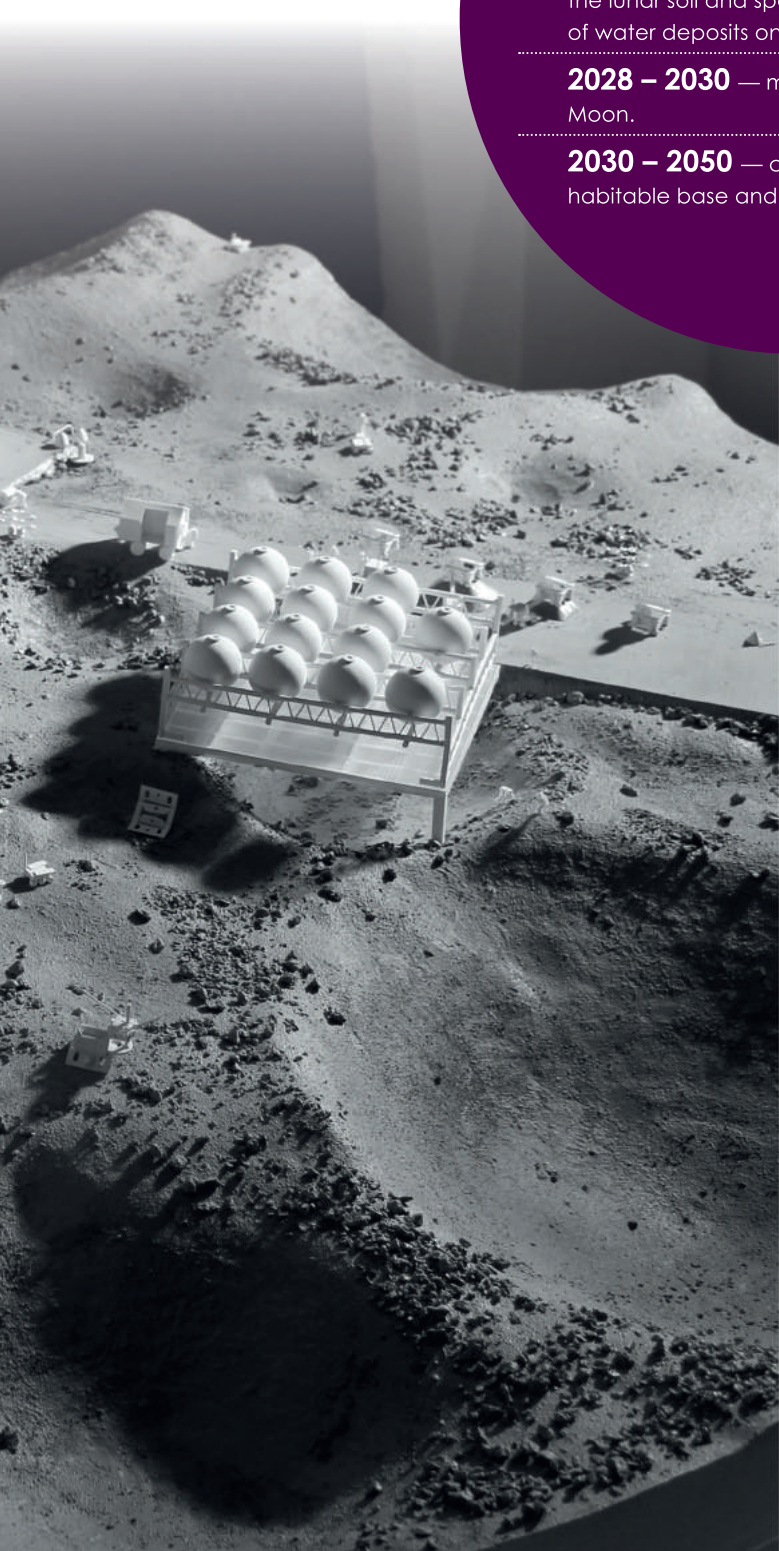



Anton RAKOV, PhD of Architecture, member of the Russian Designer Union, associate professor at the Innovative Engineering department of SSTU:

"In accordance with international agreements the Moon surface is not to be divided into pieces and sold, but they don't cover the objects delivered to the Moon or made there. It's obvious that a brand-new type business activity will appear in the near future, and it's very important for us to take part in it."

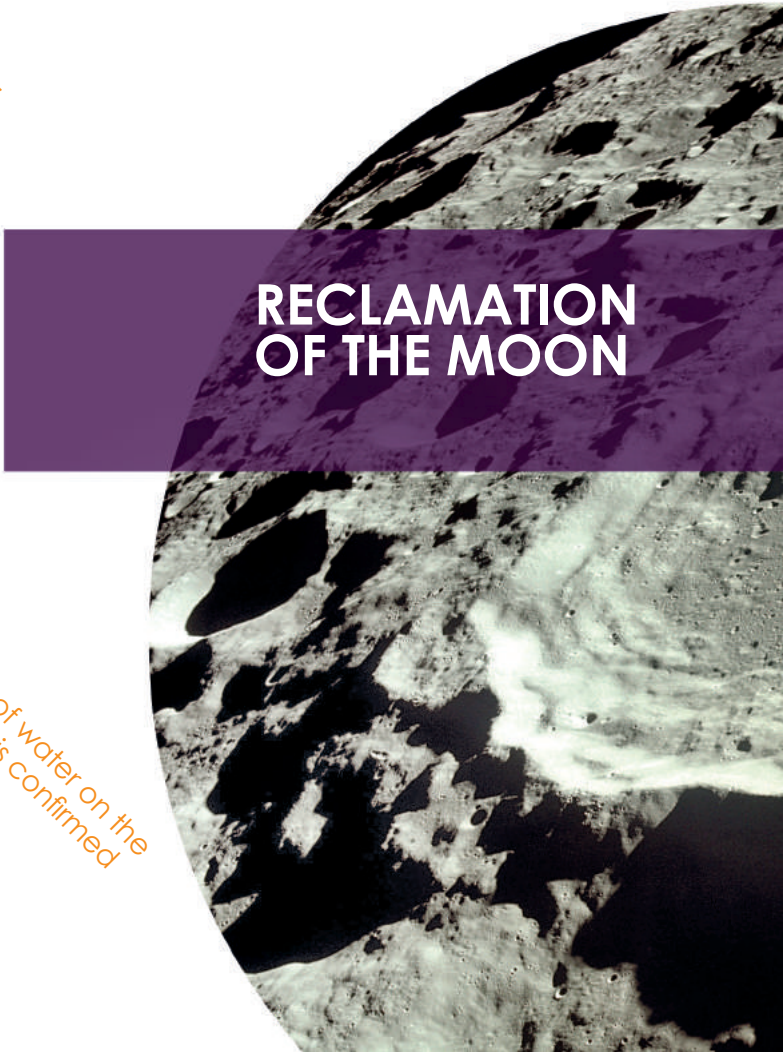
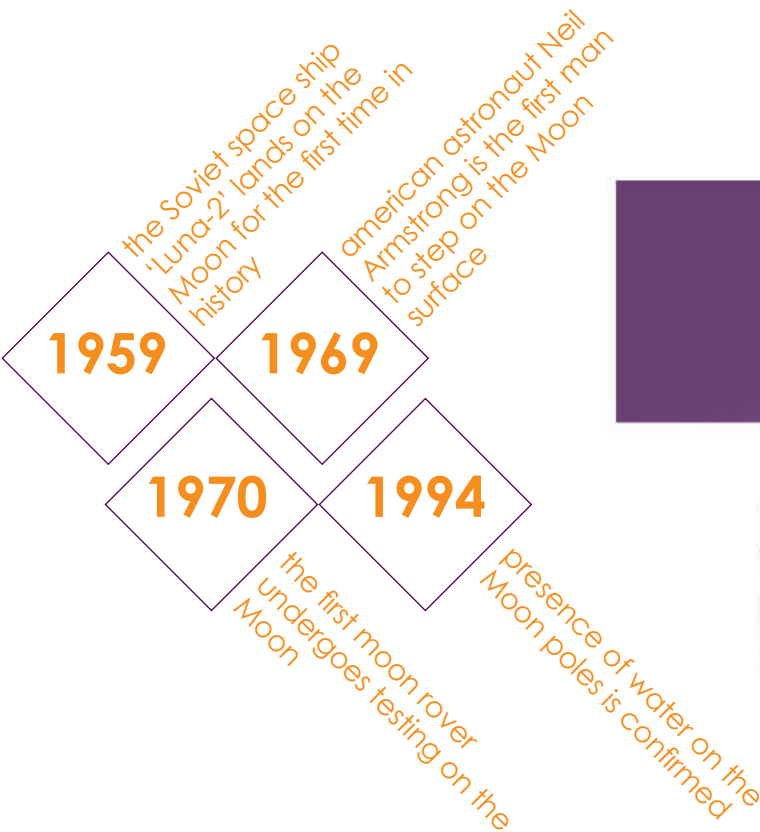

RECLAMATION OF THE MOON

glass objects of any shape; it uses sand and sunlight: the device focuses the sun rays, melts the sand, forms the required part and then lets it cool down. The 3-dimensional structure is sintered layer by layer.

Enrico Dine's 'D-shape' printer can print large stone architectural objects using liquid and powder.

But these remarkable Earth-made devices may not work on the Moon.

"We offer to use our developments on the Moon," says **Anton Rakov**, PhD of Architecture, member of the Russian Designer Union, associate professor at the Innovative Engineering department of SSTU. "We're talking about melting the lunar soil by aiming directional solar energy at it. Thus we produce rock from regolith, and this is the ideal material in terms of lunar environment. Having improved the existing 3D-printing technology we designed a model of a robotic installation – heliolithographical laboratory for construction operations."

Anton Rakov's heliolithograph consists of two units; it will focus the sunlight by means of four mirrors and melt the lunar soil into solid stone parts. A special transfer arm will be used to move regolith and regolith-made objects. Artificial moon stone will be used to build protective structures above the manufacturing objects, power generating units and accommodation modules on the Moon's surface.

Now the details of this project are still being discussed by the members of the SSTU interdisciplinary team under the guidance of Anton Rakov and Doctor of Technical Sciences professor **Vladimir Nikitin**.

Meanwhile the scientists at the leading space industry enterprise – the Simeon Lavochkin scientific- production association – became interested in the SSTU-developed project. As the result

Aleksander BAGROV, Doctor of Physical-Mathematical Sciences, leading researcher at the Astronomy Institute of Russian Academy of Sciences:

"There's no particular project of the Moon settlement so far but it really doesn't matter whether it will be a 'robot village' or a fully functional human settlement; the main point is that we have already had the technology of making 'moon bricks'. In the future the cosmonauts will produce these 'bricks' using the lunar soil, aluminum taken from the Earth and electricity generated by solar batteries. Soil is sintered into bricks in minutes so this technology is really time-saving."

of the meeting held there in November SSTU, the Simeon Lavochkin scientific-production association and the museum and exhibition center 'Samara Space' signed the tripartite agreement. The specialists are expected to build the functional prototype of the robotic installation for 3D-printing the stone objects on the Moon by the end of 2018.

FEDERAL SPACE PROGRAM AND THE CONCEPTION OF THE NATIONAL MOON RECLAMATION PROGRAM

2019

the 'Luna-25' probe ('Luna-Glob') lands in the polar area of the Earth's natural satellite to elaborate the landing system and provide the working conditions on the Moon surface

2025

manned flight around the Moon on the next-generation Russian transport ship

2030 – 2032

first Russian cosmonauts come to the Moon

2030 – 2050

construction of the habitable base and the mining operation site

IN THE STYLE OF SCIENTIFIC FUTURISM

The scientists of SSTU have told us what developments will be in demand in the near future

By Eugenia NOVIKOVA

The period from the invention of a wheel to the creation of a steam engine took more than six millennia. Gutenberg's printing press is six hundred years older than the first iPhone. Technical and technological revolution occurs so rapidly that there is no doubt that 30-50 years later the amazing new world will be very different from the modern one. We interviewed some leading researchers to get their predictions about future scientific trends.

Edgar RAPOPORT, Professor of the Chair of Automation and Control in Technical Systems, Doctor of Technical Sciences, Honored Figure of Science and Technology of Russia believes that all fundamental scientific achievements will be in demand in practice. At the same time, there are a lot of applied problems in the national industry that could only be resolved by the scientific method.



Intelligent Control Systems & Materials Science

- Materials science, the creation of new highly effective materials is a key subject today. The scientists of the Chair of Foundry and High-efficient Technologies of our university are engaged in the development of materials with memory which is one of the most advanced scientific fields.

Intelligent control systems using new information technologies will be in demand in the near future, - says Professor Rapoport.

"Further progress is impossible without widespread introduction of computer technology, especially in the operation of machines," - says Valentin Sukhinin, vice-rector of the SSTU branch in Syzran.

Alternative energy



Andrey PIMERZIN, head of the Chair of Chemical Technology of Oil and Gas Processing expects the reconstruction of the fuel and energy sector within the next 15 years.

He said that oil won't be the basic source of energy. Hydrogen produced from natural gas will take its place in the future.

The engine technology will also use hydrogen or methane as basic fuels. The methane potential is very high as it can be

used for diesel engines and high-octane engines; moreover, engines don't need significant re-engineering. The only factor that complicates the process is the infrastructure: there are not enough fuelling stations and energy materials.

Professor Pimerzin also noted that in some SSTU departments such as Department of Oil Technology, Department of Chemical Engineering and others have interesting developments appreciated by the Russian Academy of Sciences and industrial enterprises. However, they are difficult to implement because of high expenses.

- Some ideas remain unrealized because there is no efficient interaction between scientific and production facilities. Russia lacks the necessary engineering layer which would allow testing of new projects on a small scale.

Anatoly SCHELOKOV, Honoured Energy Worker of Russia, head of the Chair of Industrial Power of Samara State Technical University, highlighted the improvement of energy efficiency and reduction of energy intensity of the national economy, the load limitation of the fuel and energy complex on the environment.

- As a result, we are trying to improve local energy supply of some individual

Heat Power Engineering



remote sites. We have a patent to use aerothermal energy gradients of air-gas flows and one more patent on thermo-chemical heat reservation, - says Anatoly Schelokov. - We are also working to reduce the impact of the greenhouse gas emissions on the environment by a closed cycle of natural gas reburning.



Ecology

Honored environmental engineer of the Samara region, head of the Department of Chemical Technology and Industrial Ecology **Andrey VASILYEV** believes that oil and gas will be a significant support to the Russian budget for a long time, so it's worth making discoveries in the oil and gas sector.

- But nowadays, the environment is the main issue, - says Vasilyev. - Environmental developments aimed at eliminating biodegradation, reducing the negative impact of waste are essential.

Sergey MALAKHOV, head of the Chair of Innovative Design of ACI believes that two conflicting trends are currently in progress.

- One of them relates to a technocratic process, the creation of virtual reality technologies. The second one considers a return to the environmentally sustainable contact with nature, to the sensorial origin. From my point of view, the technocratic vector is prospectless. We might reach a dead end if we start thinking only about new technologies. Real progress can't be achieved without turning to nature, roots, humanitarian background and art. It is a case of the synthesis of two principles - art and new technologies. Even the company Apple recognized that its success would not be possible without this factor.



Biotechnology

According to **Yuri KLIMOCHKIN**, head of the Chair of Organic Chemistry of SSTU, biotechnology is another priority.

- Developments related to health levels and a high quality of life will be in demand in the near future, - he says. - The second area is a "smart" home allowing people to feel more comfortable.

In general, according to the scientists, significant breakthroughs in science can only happen at the intersection of disciplines in complex research teams.





ALUMINUM CANS RECYCLING

The center of foundry technologies in Samara State Technical University is developing metal waste recycling

By Ksenia MOROZOVA

Many engineering plants accumulate tons of metal shavings and sawdust which are sent for recycling. Obtained alloys are of not very high quality. For many years the method of aluminum waste recycling has been developed at the Chair of Foundry and High –efficient Technologies of our University. That would allow to increase the metal yield significantly and to reduce its cost. Scientists seek not just to melt low-grade aluminum waste but to synthesize a high-quality alloy with a specific, predetermined chemical composition and structure. The mechanical properties of that alloy exceed the figures of charging material alloys.

Vladimir Nikitin, Doctor of Technical Sciences, Professor, Head of the Chair of Foundry and High – effective Technologies of SSTU:

Samara State Technical University is the only institution in Samara region dealing with recycling. We know the mechanism of heredity and control of the structure and chemical composition of metals. Our scientists get high-quality alloys and form castings with improved physical-chemical and technological properties.



Just recycling

Aluminium waste in the form of shavings and sawdust are produced under mechanical processing of cast and deformed sections. But the most massive type of waste is aluminum cans. They are usually thrown in the waste bin without any concern of expensive alloy.

Foundrymen of our University decided to develop the recycling as the easiest and most environmentally friendly way of metal waste disposal. Recycling started as early as the Bronze Age when a person faced the problem of metal objects disposal. Ancient people found the most effective way of recycling by melting and casting.

The scale of pollution by metal waste in the modern world is incomparably greater than in the past. It is known, for

example, that in a borrow pit near Novosemykino hundreds of thousands of tons of aluminum bearing waste are buried causing soil and air pollution. At the same time approximately 20 times less power is required for their processing than for primary aluminum production.

Experts highlight a surprising property of aluminium to retain the same chemical composition and structure. In other words, the properties of the alloy take the properties of the charge material.

Ingots and castings

The post-graduate student of the Chair of Foundry and High-effective Technologies of our University Vyacheslav Romaniuk is doing research for his thesis “Development of technology for the synthesis of aluminum alloys using technogenic waste metal.” In the study he presents a unique technology of aluminium garbage conversion into aluminum ingots and castings for a variety of semi-finished products and components.

Synthesis of aluminum alloys from industrial metal waste



One of the main types of man-made aluminum waste is chips at the metal-working enterprises. Along with it, we recycle cans and sawdust.

We compact waste into briquettes with the aim of avoiding oxidation. It allows to seal the downloadable material and to reduce the area of contact with air.

The first batch of dry mix with flux is placed in a melter and heated up to 700 °C. The liquid metal or melt is obtained.

The temperature of cans, sawdust and chips is usually about 20 - 25 °C. If you add them into the melt, it will get a mushy state. The dry mix must be heated up to 70 - 100 °C and added in portions.

Then we complete the chemical composition of the melt to the adequate state by alloy additives. By the way, the alloying elements in this technology, with a few exceptions, are also wastes (aluminum, copper, silicon powder).



COLOURING THE SKY

Staff of the Chair of Chemistry and Technology of Organic Nitrogen Compounds in Samara State Technical University invented metal vapor generators to study the upper layers of the atmosphere

By Eugenia NOVIKOVA

Generators of barium and lithium vapor

KVa-weight – **6000** g
mass of barium – **520** g
time of work – **3** sec
KLi-weight **730** g
mass of lithium – **1.4** g
time of work – **2** sec

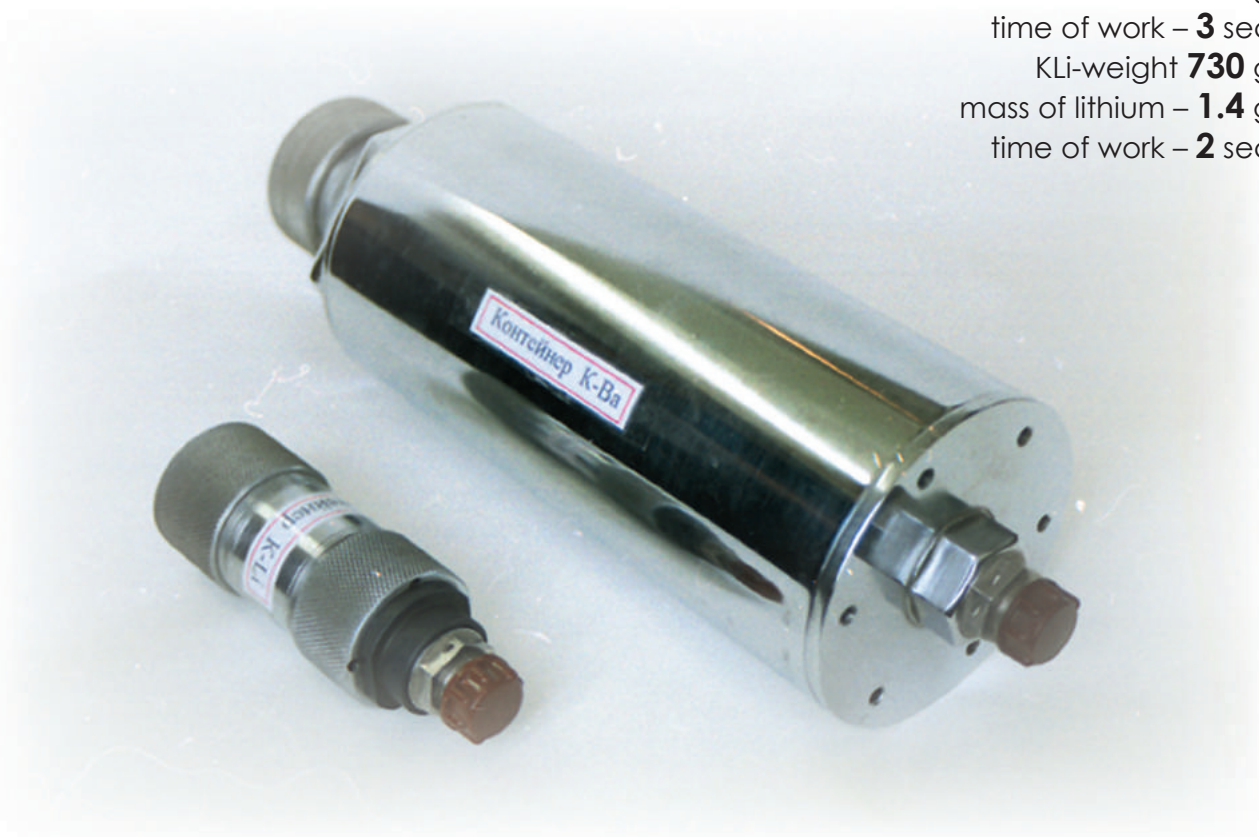

In the 1980s some strangely elongated clouds of red, green or yellow color could sometimes be seen high in the sky over the Kapustin Yar cosmodrome. Local people thought they were UFOs. Unfortunately or fortunately there was nothing supernatural in these luminous formations. They appeared due to the operation of alkali and alkaline metal vapor generators designed and assembled by employees of the Chair of Chemistry and Technology of Organic Nitrogen Compounds of SSTU.

- Our scientists were developing the technology for the preparation of various azides. There were a lot of requests concerning this topic from all over the country, - says **Vladimir Rekshinsky**, Candidate of Technical Sciences, associate professor. – The staff of the Institute of Experimental Meteorology from Obninsk (now the Scientific and Production Association “Typhoon”) asked

to produce metal pure vapor for the study of the upper layers of Earth’s atmosphere.

The mission was completed.

The method of artificial glowing clouds (AGC) is widely used for studies of the upper layers of Earth’s atmosphere. Its essence lies in the observation of optical effects caused by the release of certain chemicals into the atmosphere with the help of meteorological rockets. One of the directions of such experiments is the use of the AGC as a probe to study ionospheric and magnetospheric electric fields and the Earth’s geomagnetic field.

According to the project participants, no one has managed to come up with a better way to get metal vapor free from impurities yet. In 1983 the study was suspended for several reasons but the results were so important for various sectors of the economy that the USSR

Ministry of Defence obliged the scientists to continue the studies.

Metal vapor generators produced in SSTU used combustion processes while both domestic and foreign analogues used explosion methods. It was safer, more reliable and cheaper as the rockets containing devices located in equipment bays remained intact thus allowing other experiments to be carried out simultaneously at an altitude of 180 - 200 kilometers. It was very cost-effective (in Soviet times, the launch of a meteorological rocket cost 60 thousand rubles). Artificial glowing clouds (AGC) from a combustion process of azides did not contain impurities that affected the light intensity, and consequently helped assess the conditions better, for example, to determine the work of radio contact on a strategically important territory.

The color in this situation was due to the ionization of metal vapor. The ionized components of AGC were stretched along the magnetic lines of the Earth and looked like the clouds. The green color was produced by barium, the red one - by lithium and the yellow one - by sodium.

- We not only produced generators for the rocket and space research of the upper layers of the atmosphere but also participated in the rocket launching, - says associate professor **Alexander Pyzhov**, the Candidate of Technical Sciences. - I've been on two rocket launch sites: in Kapustin Yar and on the island of Hayes on the archipelago of Franz Josef Land. One of our staff members **Anatoly Drobyzhev** was also on the research vessel "Professor Vize" chartered by Hydrometeorological Service of the USSR to carry out rocket experiments in tropical latitudes. The work was being done in collaboration with French and Norwegian experts. All the experiments were successful.

Small-scale production of generators was carried out directly at the Chair of Chemistry and Technology of Organic Nitrogen Compounds. The devices were tested at the university center "Roscha". The generators were not very big. The hardest of them (barium) contained about 1.8 kilograms of the composition.

At present, the results of the research have not been applied as the experimental meteorology in Russia is going through hard times, while it is a rapidly growing industry abroad. NASA uses artificial glowing clouds but their technology is different from the one that was created in Samara State Technical University. Experts say that nobody has obtained the better product.

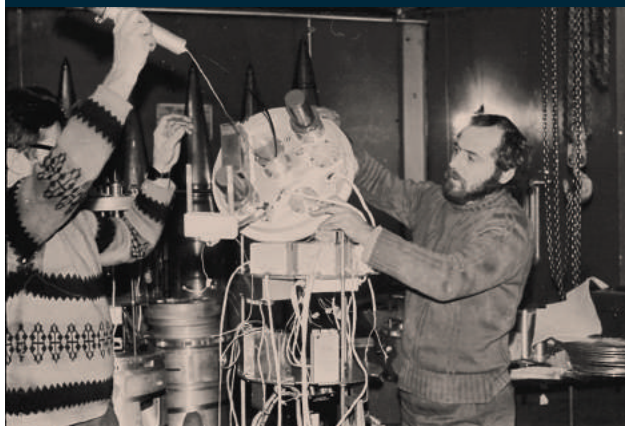

Preparations for the rocket launch





Samara Technical University Sports Center

Sport and entertainment center provides services to the students of Samara State Technical University and local residents: aerobics, martial arts, sports games, gym, and multimedia shooting gallery.

For children: swimming, karate, aikido, and dancing classes are available

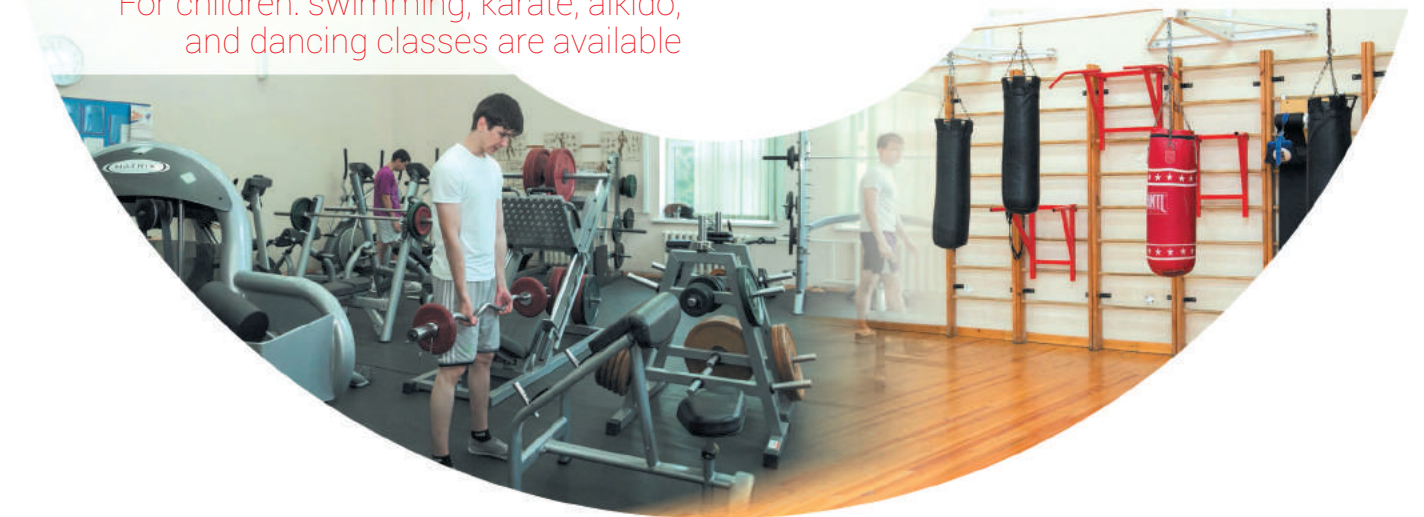
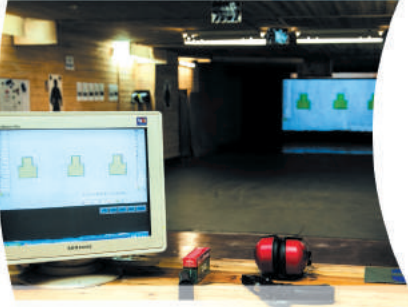

RENDEZ-VOUS WITH LABYRINTHODONT

SSTU employees participating in geological expedition found the unique pieces of ancient fauna

By Tatiana VOROBYOVA

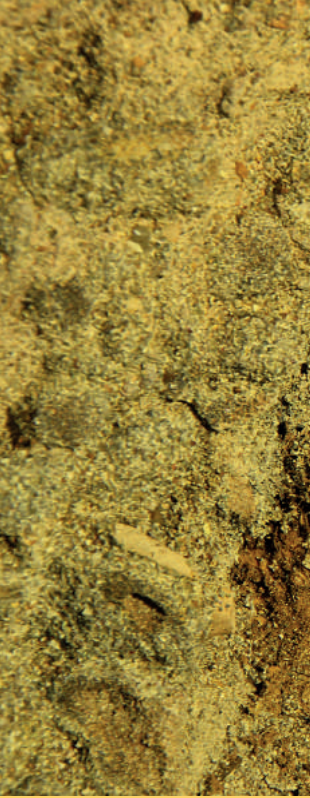

Time of individual researchers has gone. Now it's time for the groups of scientists to get interesting and sometimes unique results. This point was confirmed by the members of the joint expedition of the Paleontological Institute of Russian Academy of Sciences (Moscow), Pyotr Alabin Regional museum of local history (Samara), Ecological museum of the Volga Basin, Institute of Russian Academy of Sciences (Tolyatti), SSTU and Tolyatti local history museum; their goal was to monitor the Triassic time sediments. Igor Novikov, Candidate of Geological and Mineralogical Sciences and the leading research officer at the Paleontological Institute of Russian Academy of Sciences who participated in the expedition, told our magazine about the pieces the experts found in Samara and Orenburg regions and about their scientific value.

Pieces found at the Obshiy Syirt

“During the expeditions that we’ve done over the past two years we found many interesting things. They all confirmed a theory suggested a long time ago that the Obshiy Syirt – an elevation situated on the territory of Samara and Orenburg regions – was like a ‘door’ through which fauna from Gondwana (in this case – from Southern Africa) used to penetrate to Eastern Europe. Several life forms previously associated with Southern Africa were found only on the Obshiy Syirt over the last decades.”

This year, just like a year ago, our expedition has concentrated on searching for the remains of terrestrial vertebrate species at the bottom of the Triassic sediment cut (Triassic time was the beginning of Mesozoic era). These sediments formed right after the so-called environmental crisis at the turn of Permian and Triassic times when 70-80 per cent of marine and terrestrial fauna became extinct and vertebrate community was severely impoverished. Study of these post-crisis communities that appeared at the very beginning of Mesozoic era is very important for science.

There are very few places on the planet where they can be found and studied. The Obshiy Syirt is one of them.

This year for the first time the expedition was organized with use of SSTU technical potential: the university gave the researchers a truck.

“Thanks to it we were able to do our research over a larger area,” **Igor Novikov** goes on. “We monitored over twenty locations. Even though our expedition lasted for one week we found a number of unique pieces dated to early Triassic time. We found two fragments of skulls and several isolated bones of labyrinthodont – an ancestor and a distant ‘relative’ of modern frogs. The two halves of the skulls belonged to different animals.”

Alyona Morova, senior lecturer at the Geology and Geophysics department of SSTU, found one of the pieces.

Novikov says that the geologist hit the right spot with her hammer and a half of the labyrinthodont skull fell out of the rock. Unfortunately, it fell into pieces right away so it took three days to glue them back together.

Igor Novikov found an occipital part of labyrinthodont skull at another location. Such rare findings – two incomplete skulls of early specimens belonging to two labyrinthodont families once again showed to the research team that the fauna of the Obshiy Syirt is unique and cannot be found anywhere in the world.

Looks like a crocodile

“But to find a skull and bones is only a half of success,” Igor Novikov says. “Next step is to retrieve them from the rock without any damage. There are certain

In the beginning of the Mesozoic era there were no such rivers as the Volga and the Ural. There were lots of small rivers coming down from the Urals which were 5 kilometers high. Sediments were forming on the bottom of the riverbeds (these sediments later became the subject of the study), and the banks were inhabited by the ancestors of frogs (labyrinthodonts) and dinosaurs (theodonts).

ways to do that. First the bones are dried out and then imbued with special glue, and only after that is done they can be carefully extracted from the rock. There were several cases when researchers had found complete skeletons but couldn't retrieve them as ancient bones would turn to dust.”

The scientists are able recreate the labyrinthodont's appearance using the skulls and bones they found. It looked like

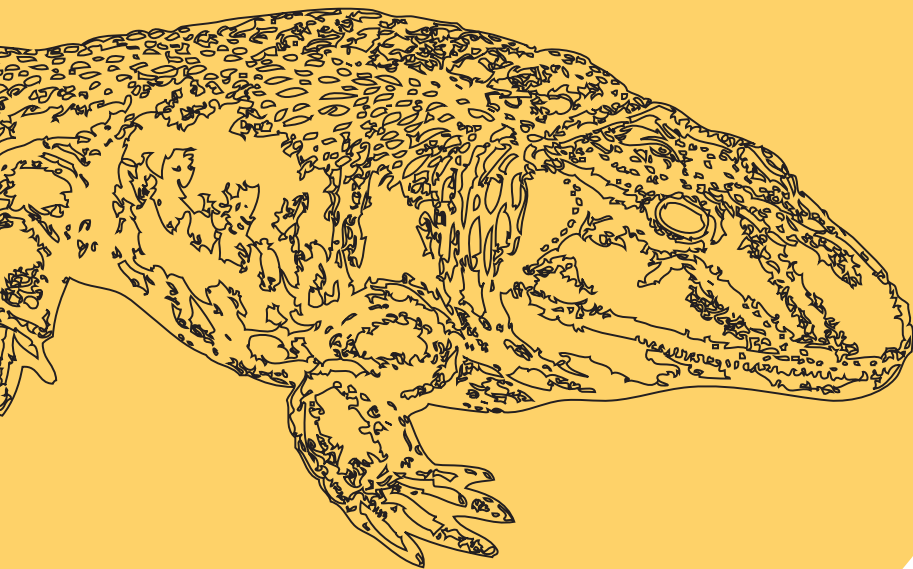

chemical treatment with use of acetic acid – for further study. This process takes a long time and should be completed next month.

“We put together fragments of different skulls found in different places, just like a puzzle; thus we recreate the whole skull and find out its morphological features,” the key research officer of the country’s major paleontological institution explains. The materials he obtained in the expedition became the basis of his doctoral thesis and now it’s almost finished.

Opening new horizons

“Unique pieces found at the Obshiy Syirt helped us solve both biological and geological problems,” Igor Novikov says. “On the one hand it made it possible for us to review the origin of some labyrinthodont groups, and on the other hand – to single out a new horizon in the early Triassic time of Eastern Europe. We call it Zaplavnoe after the village of Zaplavnoe where the stratigraphic section is situated.

A horizon is a geography-specific epoch, a separate stratigraphic subdivision which is characterized by the peculiar terrestrial group of vertebrate species. Until now the Zaplavnoe horizon was considered not as a separate layer but rather as a part of a lower Volkhominskoe horizon despite the fact that associated fauna of these two layers is slightly different. It should be noted that the Zaplavnoe horizon is one and the only (for the time being) regional stratigraphic subdivision of the Triassic time,

stratotypical (reference) cut of which is singled out on the territory of Samara region.

From my point of view, the early Triassic of the Obshiy Syirt can be presently divided into 8 consecutive levels according to the features of the terrestrial vertebrate fauna. Such detailed division of the continental Triassic (i.e. the sediments formed at the river or lake basins about 230-220 millions of years ago) cannot be found anywhere in the world.

Detailed division of the Triassic sediments – up to 8 levels – is of practical importance for the geologists as these sediments may be oil-bearing in some regions (for example, in Pechora). Information about each level can help the geologists to discover mineral. And this is one of the main goals of paleontology.”

Labyrinthodont is the extinct subclass of amphibian; most of them lived on the Earth in the Paleozoic and the Mesozoic eras (390-150 millions of years ago). Labyrinthodonts are the ancestors of all mammals, from mice to elephants. They inhabited our region long before the dinosaurs.

The Obshiy Syirt is the sag-and-swell elevation situated in the south-east of the European part of Russia and Kazakhstan where the basin of the Volga borders on the Ural basin. Gondwana was the ancient continent situated on the southern hemisphere; it incorporated modern Africa, South America, Antarctica, New Zealand, Arabia, Madagascar and India.

a crocodile but they are not related at all: a labyrinthodont is an amphibian and a crocodile is a reptile. In early Triassic time the maximum length of a labyrinthodont was from 1.5 to 2 meters and by the middle of Triassic time they might have been 4-5 meters long. The remains found in Samara region lead to the conclusion that labyrinthodonts that inhabited this area 220-225 millions of years ago were 10-1.5 meters long.

Now the skulls and bones are in the Paleontological Institute of Russian Academy of Sciences where they are undergoing the process of preparation –



Scientific expedition for monitoring the fauna of the Triassic sediments





▲ General appearance of the piece of sandstone with the fern impression, counterimpression and wood.

Paleontology

SCIENCE AND ...

STRAIGHT FROM PALEOGENE

A unique imprint of ancient fern is found in Samara region

By Tatiana VOROBYOVA

Last summer the scientific expedition organized by Samara regional museum of local history made an unexpected discover. They found the imprints of an ancient thelypteris-like fern leaves in the career near the village of Trubetchino in Syzran region.

Previously the only place where the thelypteris fern belonging to the extinct genus called Speirseopteris was found has been the Paleocene sediments in Canada. It has never been found on the territory of Russia before.

“This is the first time we have found ancient fern flora in the paleogene

sediments on the territory of our region,” says **Vladimir Morov** who lectures at the Geology and Geophysics department of SSTU and who participated in the expedition. He explained that the SSTU experts examined the imprints together with the representatives of Ecological museum of the Volga Basin Institute of Russian Academy of Sciences (Tolyatti) and geologists from Samara State Architectural University. Sergey Vikulin, a scientist from

Fragments of leaves of the *Speirseopteris* sp. fossil fern (1 – the imprints; 2 – the counterimpression). ▶

St. Petersburg, Candidate of Biological Sciences, senior research officer of the paleobotany laboratory at Komarov Botanic Institute of Russian Academy of Sciences, expert in Paleogene and Eastern Europe flora, also took part in the process. It was him who identified the age of the fern – 55-59 millions of years.

Results of the research were confirmed in the article published in the 'Phytodiversity of Eastern Europe' magazine issued under the aegis of the Institute of the Volga Basin Ecology of Russian Academy of Sciences. The article was written by Sergey Vikulin, **Dmitriy Varyonov** (officer of the Nature department of the Pyotr Alabin museum) and **Alyona Morova** (senior lecturer at the Geology and Geophysics department of SSTU) who described the geology of the piece.

"We think that the piece of the thelypteris-like fern from that we found in the Paleocene sediments of Samara region belongs to the Canadian Paleocene sort of *Speirseopteris*. We require more well-preserved pieces of vegetative and sporogenous leaves with fine nervature of segments to identify this Paleocene *Speirseopteris* fern more accurately and provide a reliable description of this new sort," the authors say.

So, the Russian scientists in close cooperation with the SSTU experts proved that there were morphologically alike forms of the Paleocene ferns in the Paleocene of northern hemisphere (middle latitudes of Eastern Europe and Southern Africa); these ferns had some common features (for example, leaf nervature morphology) with chiefly thermophilic modern ferns of the *Thelypteridaceae* family.

The newly found piece with the impression of ancient fern leaves will soon become a part of the exposition at the Pyotr Alabin museum.

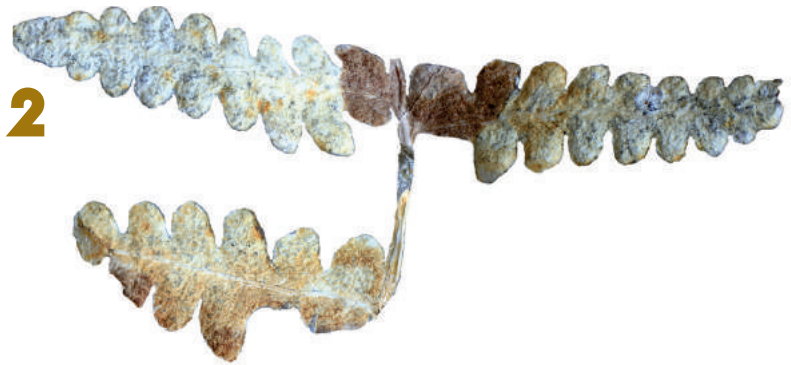

▲ 3 – a fragment of a frond of the modern marsh shield fern (*Thelypteris palustris*) which is one the closest sorts of the extinct genus of *Speirseopteris*.

* A frond (Greek *baion* – a palm branch) – a large compound thing that looks like a fern leaf.



▲ 5 – Magnified nervature of the leaf on the *Speirseopteris* sp. impression.

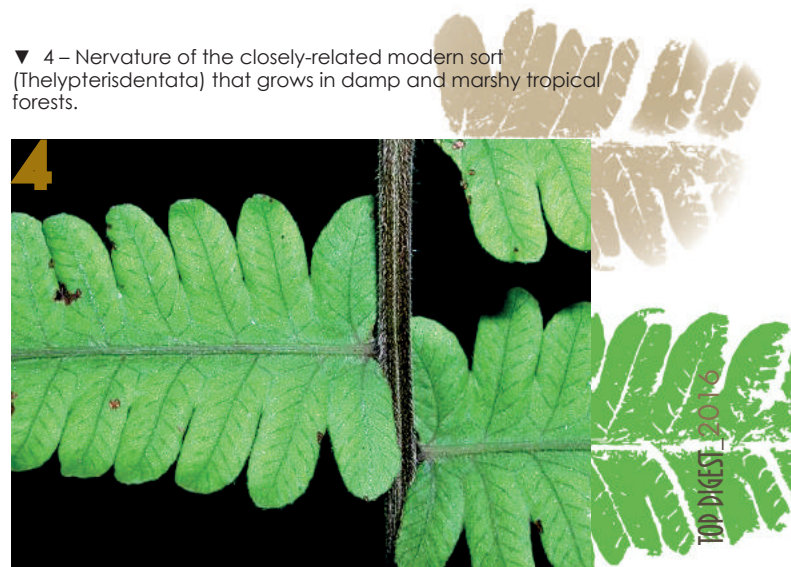

▼ 4 – Nervature of the closely-related modern sort (*Thelypteris dentata*) that grows in damp and marshy tropical forests.

THE HIDDEN BEAUTY

The Geological and Mineralogical museum of SSTU has interesting jasper samples

By Eugenia NOVIKOVA, Alexander SIDOROV

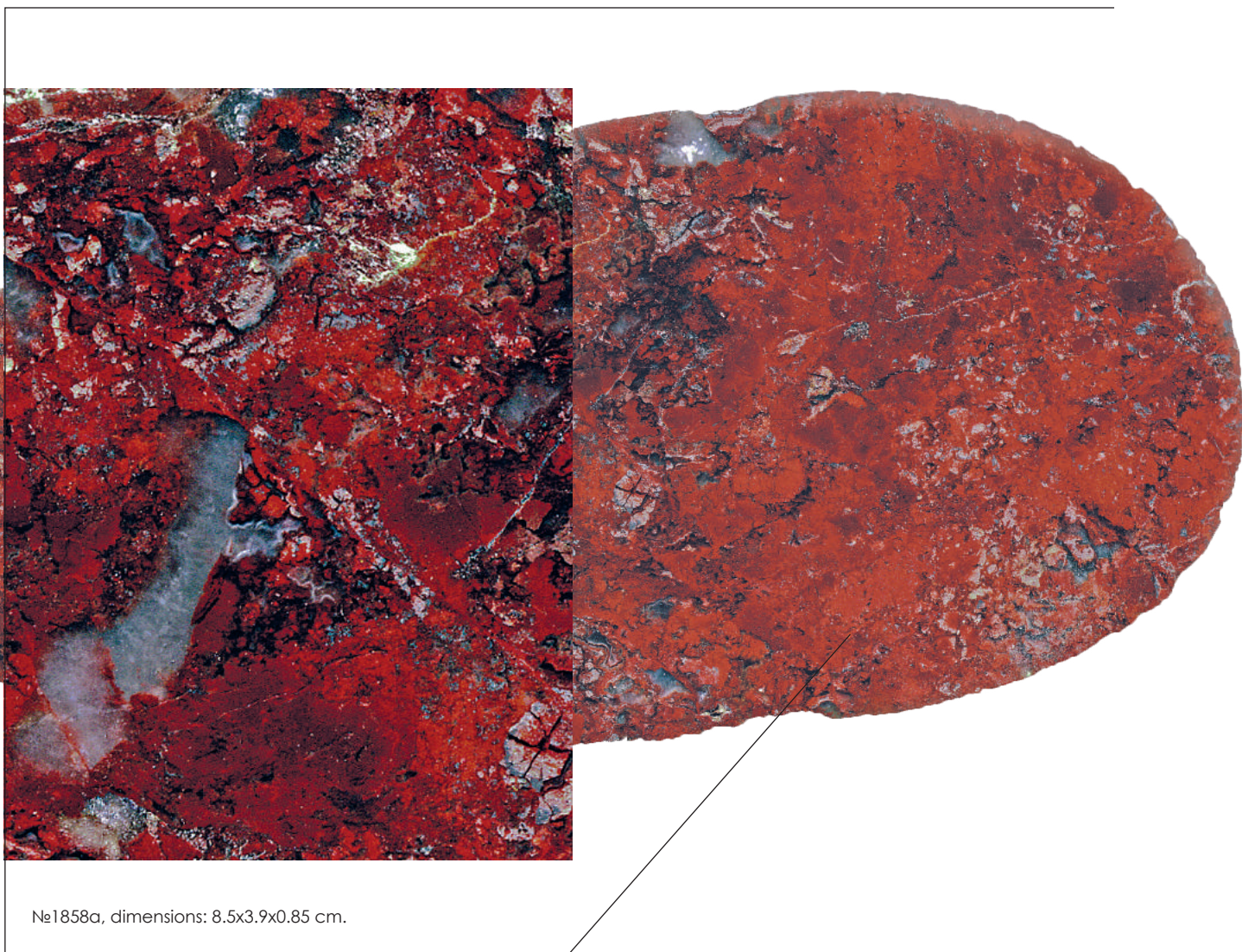

The exposition of Geological and Mineralogical Museum of SSTU is constantly updated with new samples of rocks. This year, for example, the museum's director **Alexander Sidorov** have got some samples of sawn and polished jasper found in the Samara region.

- Jasper practically does not occur in our area. It's a great success to find a few samples in Samara region, - says Sidorov.

Jasper was found in the Podgorninskiy gravel deposit. According to geologists millions of years ago the siliceous rocks were moved and weathered by stormy river flows from the Urals which is the main store of colored stones in Russia.

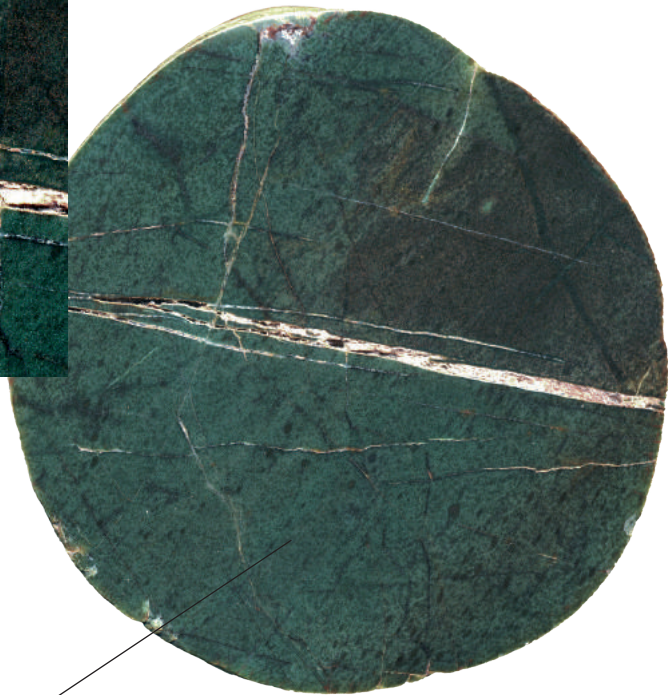

№18596, dimensions: 7.9x7.5x1.6 cm.

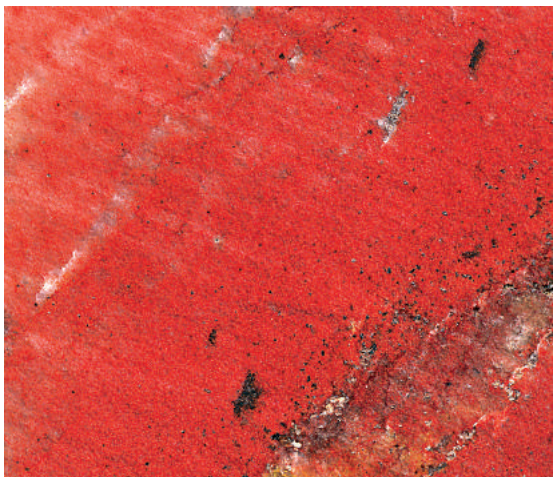

№1766, dimensions: 9.1x 6.3x1.9 cm.

- The rock was formed as a result of the mixing of bottom sediments with magma which came to the surface after the volcanic eruptions. In the Samara region there are no volcanoes, - says Sidorov.

Jasper is a stone with a secret. You can appreciate it in all its glory only in the cut. Several polished specimens have already been exhibited in our museum. They look

like watercolor landscapes painted by nature. Such samples of landscape jasper are particularly valuable because it is not easy to find them even in the Urals. To cut them correctly is also not an easy task.

According to geophysicists the age of the rock corresponds to the Devonian

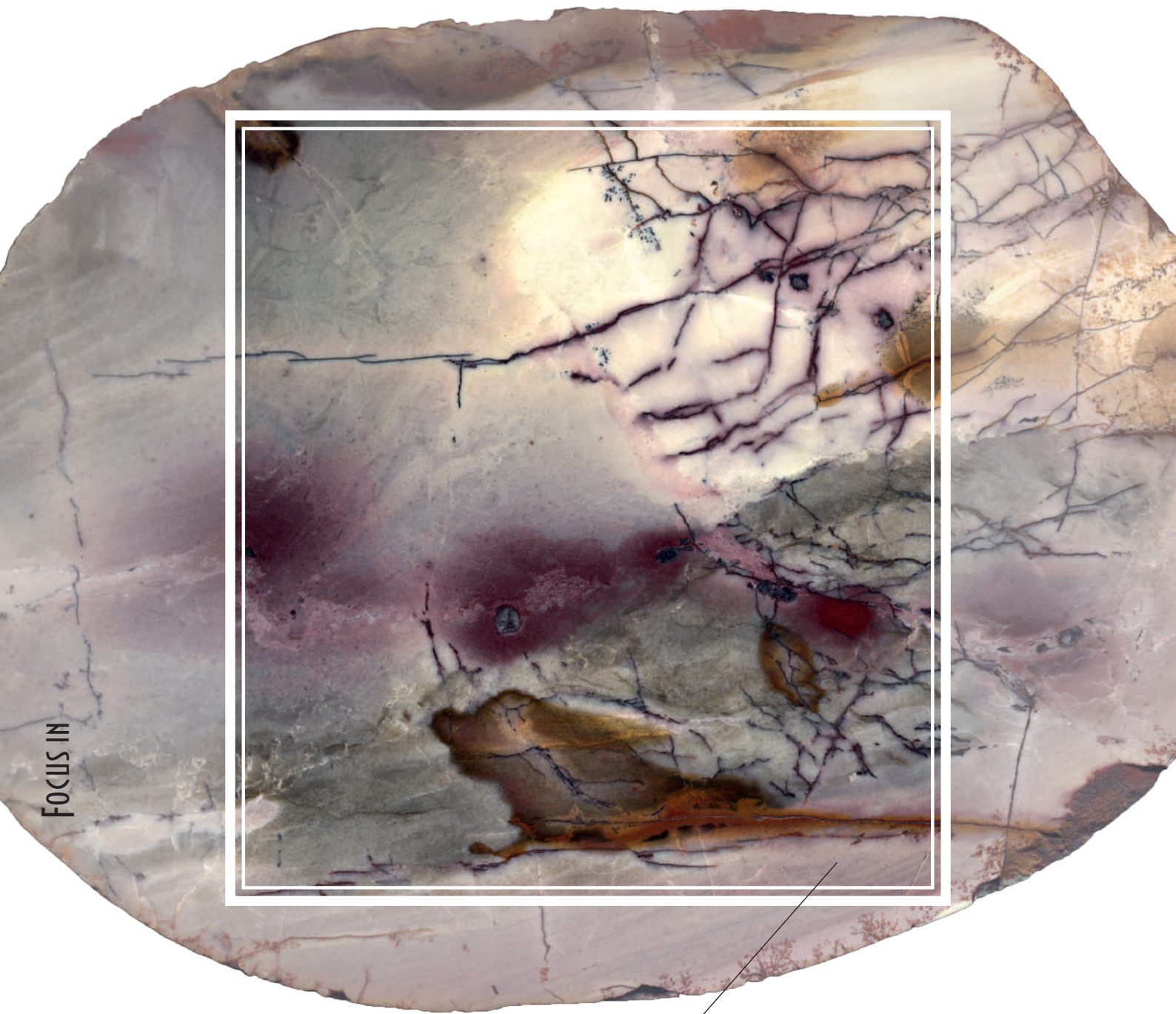

FOCUS IN

№1757, dimensions: 11.3x8.0x5.1 cm.



№1744, dimensions: 7.0x7.0x3.0 cm.

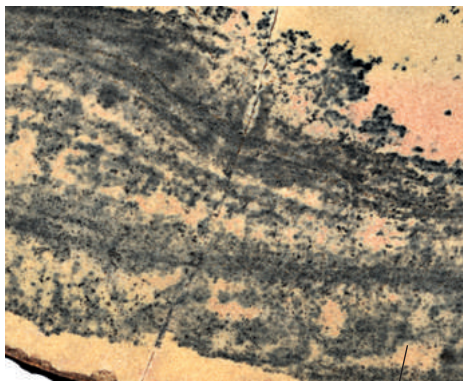
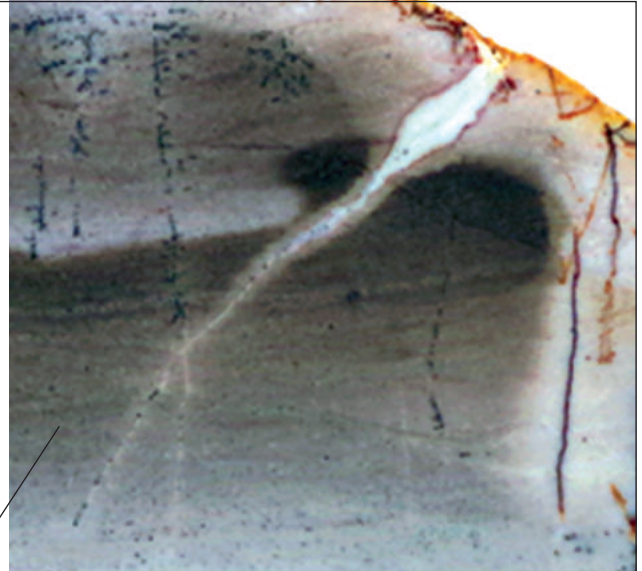

№1860, dimensions: 8.5x7.1x2.4 cm.

period (fourth geological period of the Paleozoic era). There was a sea on the site of the Ural Mountains 390 million years ago. The underground volcanoes erupted magma which mixing up with the remains of single-celled planktonic organisms (radiolarians) created fascinating patterns.

Jasper has been praised at all times. In the Stone Age people used it for making hammers, axes, arrowheads, knives. American Indians valued jasper more than gold for its special sacred properties. This stone has been used in making a variety of jewelry and decorative items from the eighteenth century to the present. Masterpieces of the stone-cutting art adorn the museums all over the world.

- Our collection of jasper found in Samara is unique because the samples traveled thousands of kilometers, - says Mikhail Bortnikov, a senior lecture of the Chair of Geology and Geophysics in Samara State Technical University. - Despite the fact that in 1960s jasperoid pebbles were found in Samara region, only Alexander Sidorov decided to study the samples. He was the first to saw and polish the stones. I think these findings will be of interest to specialists who collect small pieces of jasper for mosaics.

In the collection of geological and mineralogical museum there are jasper samples both of homogeneous color (for example, №1858a and №1859b) and landscape ones (№ 1860). This is the first and the only collection of ornamental stone in the Samara region.

TECHNOPOLIS OF THE VOLGA REGION



<https://samgtu.ru/university/technopolis-volga-region/>

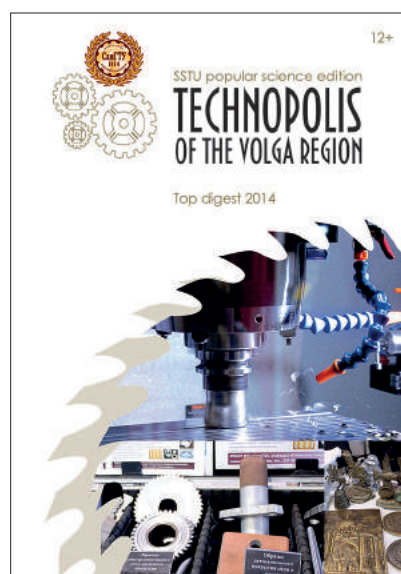
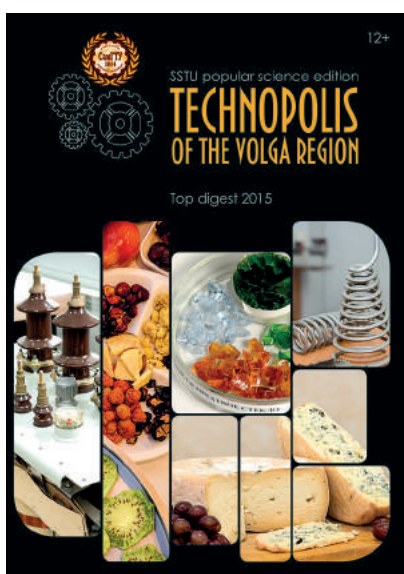

■ EXPLOSION WITH NO REGRETS

Scientists of Samara State Technical University developed a universal rolling method which allows the production of linear-shaped charges of any length and yield

■ SSTU SPECIALISTS KNOW HOW TO DRAW FIBER

One of the few semiautomatic optic fiber production experts in the world works in Samara State Technical University

■ LIFE AND INCREDIBLE TRANSFORMATIONS OF SULPHIDE LEACH

Things that specialists at Samara State Technical University can make out of toxic explosive production waste

■ LOST IN STEPPES

A story about amazing things sometimes found under the feet of SSTU students and lecturers

■ TASTE EXPLOSION

In Samara State Technical University the production of freeze dried food is set up

□ THE BEAUTY OF HOT METAL

The faculty of the casting technology center at Samara State Technical University proved that metals have heredity

□ INDEPENDENT CRUISE

Scientists at Samara State Technical University built a general-purpose vehicle to explore the depths of the sea

□ SAMARA-STYLE CALVADOS

SSTU has patented a new method of apple brandy production

□ MATHEMATICAL ANALYSIS HAS EXPANDED THE POSSIBILITIES OF TRAUMA MEDICINE

A SSTU graduate student has devised a solution for femoral neck fractures

ALPINE-ZHIGULI BUSINESS CENTER

The area of international cooperation
of Samara State Technical University



**We give new opportunities for your
business in the heart of Russia**

EXCHANGE PROGRAMMES for

- students
- educational projects
- technologies
- services

SUPPORT
to business
organization



PROGRAMMES
of business and family
tourism



**SUMMER LANGUAGE
SCHOOL**
for applicants over
18 years old



**ORGANIZATION
of INTERNATIONAL
COURSES** on:
wine production,
brewing,
cheese making



WELCOME TO SAMARA!

12 Novo-Sadovaya Str., Samara, Russia, 443100
Tel: +7 (927) 717-77-58,
bickowagalina@yandex.ru
ADS.SAMGTU.RU



Science and Innovation are
for the prosperity of Samara and Russia

Dmitry Bykov: "We will
invest everything in
human capital Aluminum
cans recycling Colouring the
sky Innovation experience From
Samara to Lille and back Our people in
Kudankulam Demand for
Innovation According to UNESCO
Innovation teams
Take it on measure Phenomenal
reaction Recycling instead of waste
destruction A cluster of drones Deodorant for
odorant No vibration – no hesitation
Nano blast Sludge was
given a chance Analyze
this Baking as a science Rendez-
vous with labyrinthodont
Straight from Paleogene Show me
a moon stone In the style of scientific futurism
Geniuses of SSTU
The hidden beauty